

**JUNE 2005**

**WHOLESALE PRICE LIST**

**CATALOG #105**

---

14002 CANYON ROAD E. • PUYALLUP, WASHINGTON 98373  
(253) 531-9132 • FAX (253) 531-8271 • 1-888-531-9132  
email: [sales@ruckmanscabdoor.com](mailto:sales@ruckmanscabdoor.com)



# DOOR ORDER FORM

CUSTOMER _____	JOB NO./NAME _____
ADDRESS _____	P.O. # _____
PHONE _____	FAX _____
	EMAIL _____

MATERIAL _____
INSIDE STILE/RAIL PROFILE _____
MITERED DOOR PROFILE _____
APPLIED MOLDING PROFILE _____
RAISED PANEL PROFILE _____
OUTSIDE EDGE PROFILE _____

<b>FINGER PULLS</b> <input type="radio"/> FULL WIDTH <input type="radio"/> FULL WIDTH TOP & BTM	<b>HINGE BORING</b> <input type="radio"/> 35mm <input type="radio"/> BLUM 35mm/2mm <input type="radio"/> BLUM 35mm/8mm <input type="radio"/> 3mm OFFSET <input type="radio"/> 5mm OFFSET
---	---

	QTY	WIDTH	HEIGHT	STYLE	COMMENTS
1					
2					
3					
4					
5					
6					
7					
8					
9					
10					
11					
12					
13					
14					
15					
16					
17					
18					
19					
20					
21					
22					
23					
24					
25					
26					
27					
28					
29					
30					

SHIPPING INSTRUCTIONS \_\_\_\_\_

# TABLE OF CONTENTS

General Information / Terms / Ordering .....	2
Pricing Information / Will Call .....	3
Shipping / Warranty .....	4
Door Options .....	6-8
Inside Profiles .....	10
Raised Panel Profiles .....	12
Outside Profiles .....	14
Back Edge Profiles .....	16
Raised Panel Doors .....	18-22
Raised Panel Drawer Fronts .....	24
Recessed Panel Doors .....	26-30
Recessed Panel Drawer Fronts .....	32
Glass Frame Doors .....	34-38
Glass Mullion Doors .....	40-44
Mitered Door Profiles .....	46-47
Mitered Raised Panel Doors .....	50
Mitered Recessed Panel Doors .....	52
Mitered Glass Doors .....	54
Mitered Glass Mullion Doors .....	56
Mitered Drawer Front Profiles .....	58
Mitered Raised Panel Drawer Fronts .....	60
Mitered Recessed Panel Drawer Fronts .....	62
Applied Molding Profiles .....	64
Applied Molding Raised Panel Profiles .....	66
Applied Molding Raised Panel Doors .....	68
Applied Molding Recessed Panel Doors .....	70
Applied Molding Glass & Mullion Doors .....	72
Slab Doors .....	74
Slab Drawer Fronts .....	76
Dovetail Boxes .....	78-79

# General Information

The Lead Time on standard orders is 6-10 working days, not counting the day the order is placed. Custom orders will be somewhat longer. Orders can not be processed until all required information is provided.

Our Order Desk hours are 7:00 AM to 4:00 PM Monday thru Friday. Orders received after 4:00 PM will be handled as a next day order.

Orders may be placed in person, by Phone, by Fax, or by Email.

## Terms

Payment terms are COD unless otherwise arranged with our credit department. If you wish to apply for an account, please request an application form from our credit department. Applications take two weeks to process. Accounts are Net the 10th of the month.

First time orders from new customers may require a deposit before processing.

## Ordering

When ordering, Fax or Email orders are suggested to minimize errors. Order Forms are available upon request, or the Order Forms at the front and back of this catalog can be copied. To avoid duplicating orders, do not refax or reEmail an order without denoting such as a duplicate.

Phoned in orders will be read back to verify accuracy of dimensions and quantities.

Ruckman's assumes no responsibility for incorrect or illegible information received by Phone, Fax or Email. All orders are considered to be correct and firm.

When placing an order, please define: Material, Inside (stile/rail) Profile, Outside Edge Profile, Raised Panel Profile, Quantity, Door Size (WxH), and Door Style.

Dimensions should be for exact door, drawer front, and drawer box sizes. Do not give opening sizes.

Sizes can be provided in either inch or millimeter form. Dimensions should be specified to the nearest 1/16", or the nearest whole millimeter.

Changes to orders or cancellations may be subject to a Change Order Charge as determined by Ruckman's. Changes may also impact completion dates.

# Pricing Information

All door and drawer front pricing is per square foot. Drawer box pricing is also per square foot using the denoted formula.

All doors and drawer fronts finish at 13/16".

The minimum charge on all five piece doors and drawer fronts is for 2.00 square feet.

The minimum charge on slab door and drawer fronts is for 1.00 square foot.

All doors and drawer fronts are priced per square foot to the nearest one-hundredth. Width (inches) x height (inches) divided by 144 = square foot. (Example: W (16") x H (29") divided by 144 = 3.22

Square foot pricing does not include outside edge or back edge profiles. For outside edging add \$.50 per sq. ft. (\$.75 per sq. ft. for those edges with an upcharge). Back edge profiles if used, are an additional \$.25 per sq. ft. Doors without edging have a square, edge sanded, outside edge.

Finger Pulls are available with an additional \$.75 per door and drawer front. See Door Option section of this catalog.

Slab drawer fronts 2 sq. ft. and larger will be priced as slab doors.

Paneled doors 48" long and longer will be fabricated with a center rail at a \$5.00 upcharge, unless otherwise specified. Special placement of the center rail is an additional \$5.00.

Panels and wide doors that require addition of a center stile (mullion) will have an upcharge of \$5.00.

Glass door frames are rabbeted to receive glass. Glass and stops are not provided. Arched type doors are squared out at the top.

Paint grade lumber is mill choice.

Doors with other than standard stile/rail sizes will have an upcharge applied.

PRODUCT PRICING AND SPECIFICATIONS ARE SUBJECT TO CHANGE WITHOUT NOTICE. THIS PUBLICATION SUPERSEDES ALL PRIOR SPECIFICATION AND PRICING DATA.

## Will Call

Will Call orders should be available the day after the acknowledgment completion date. Please contact Ruckman's in advance of pick-up to ensure order availability.

Ruckman's will not be responsible for any damage to orders left in Will Call for more than 15 days after completion date.

Orders left in Will Call beyond 30 days will be assessed a storage fee.

## Shipping

All prices are F.O.B. our factory, Puyallup, Washington.

Delivery service via our truck is available in most parts of Washington. Please check with us to determine if you are on one of our delivery routes.

All common carrier and UPS deliveries will be shipped freight collect unless prior arrangements have been made.

## Warranty

All doors are warranted to be free from defects in material or workmanship, which would make them unserviceable, for a period of one year from the date of invoice.

Natural variations in the grain, texture, or color of the wood, and seams in plywood are not considered to be defects.

A tolerance of +/- 1/16" applies to all dimensions.

A twist or warp of up to 3/16" shall not be considered a defect.

Five piece doors that are 24" wide or wider or are 48" long or longer, must receive a center stile or center rail to be covered by this warranty.

Solid slab doors are not covered by this warranty.

Doors which have an improper finish and/or have been exposed to high humidity and/or moisture are not covered by this warranty.

Doors installed outside the continental United States are not covered by this warranty.

**THIS WARRANTY IS LIMITED TO REPAIR OR REPLACEMENT OF DOORS F.O.B. OUR FACTORY. NO OTHER WARRANTIES OF ANY KIND, EXPRESSED OR IMPLIED, APPLY.**

Defective items must be returned to our factory for verification before repair or replacement can commence. OUR LIABILITY SHALL BE LIMITED TO THE NET INVOICE PRICE OF THE ITEMS IN QUESTION. UNDER NO CIRCUMSTANCES IS OUR COMPANY LIABLE FOR ANY INCIDENTAL, SPECIAL, OR CONSEQUENTIAL DAMAGES OR LOSS OF PROFITS.

# DOOR OPTIONS

# Door Options

## Lazy Susan Doors

Lazy Susan doors may be ordered with a wide stile, with no edging. On one door the wide stile is 3/4" wider than the called out frame size. The other door may be ordered with no edge on one side, or both doors may be ordered with standard frame size and no edge one side.

ADD \$2.50 each door for the wide stile with no edging.  
ADD \$1.00 each door for no edging one side.

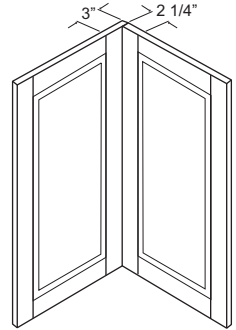

## Grooved Panels

Grooved reversed raised panel doors may be ordered by calling out the desired F or G series, reversed raised panel. Panel grooves are on 1-1/2" centers. Other spacing available upon request.

ADD \$1.50 per Sq Ft for F-F & F-V reversed raised panels.  
ADD \$2.50 per Sq Ft for G-R & G-V reversed raised panels.

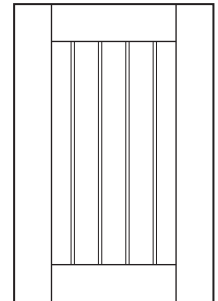
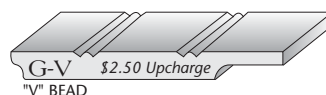
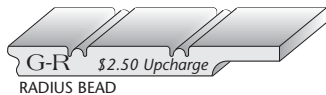
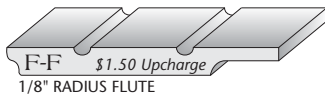

## Radius Corners

Radius Corner slab doors (1010) and slab drawer fronts (1015) as well as five piece doors and drawer fronts are available with a 3/8", 1/2", or 3/4" radius corners. The standard radius is 3/4" and will be used if no other radius is defined. Radius corners are available only with edge profiles E-5, E-6, E-12, E-13, & E-14.

SEE pricing matrix for slab doors and drawer fronts.  
ADD \$2.00 each for five piece door and drawer front.

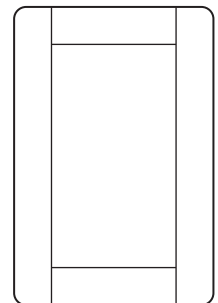

## Accent Pegs

3/8" Square accent pegs are available on all doors and drawer fronts. They are available in Cherry, Red Oak and Walnut.

ADD \$1.00 per Accent Peg.

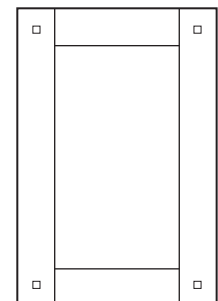



# Door Options

## Hinge Boring

Doors are available with a 35mm hinge hole bored on 3-1/2" centers from the top and bottom of the door. The hinge hole offset is either 3mm or 5mm. A third, centered, hinge hole is automatically added to doors 48" long or longer. Hinge hold boring on other than 3-1/2" centers is available upon request.

ADD \$.75 per hinge hole.  
ADD \$1.00 per custom hinge hole location.

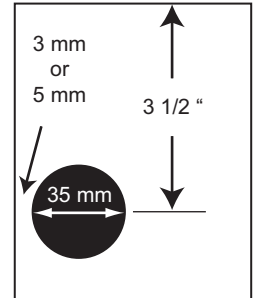

## Finger Pulls

Doors are available with either Full Width or 4" Wide Finger Pulls. Full Width Finger Pull is considered to be the Standard Pull and will be used if type of pull is not defined.

ADD \$.75 per Full Width Finger Pull, top or bottom.  
ADD \$1.50 per Full Width Finger Pulls, top and bottom.  
ADD \$1.00 per 4" Wide Finger Pull, top, bottom, left, or right.

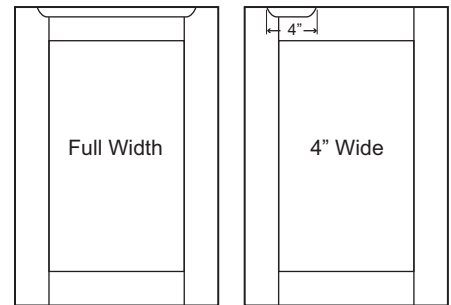

## Beveled Glass Routing

Arched glass doors are available with routing for Beveled Glass.

ADD \$2.50 per arched door.

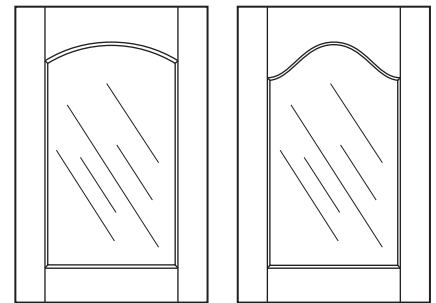

## Arched Panel Valances

Custom arched recessed panel and raised panel Valances and Oven Hoods are available. Please provide a sketch or a drawing.

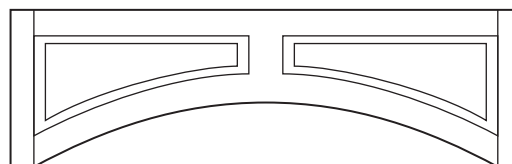

# Door Options

## Wood Species

In addition to the wood species shown in our pricing matrixes, these species are available:

Jatoba	Qtr Sawn White Oak	Rustic Alder	Rustic Maple
Lyptus	Rift Cut Red Oak	Rustic Cherry	Rustic Oak
Qtr Sawn Red Oak	Rift Cut White Oak	Rustic Hickory	Western Maple

## End Panels, Back Panels, and Wainscot

Custom End Panels, Back panels, and Wainscot Panels are available. Please provide a sketch or a drawing.

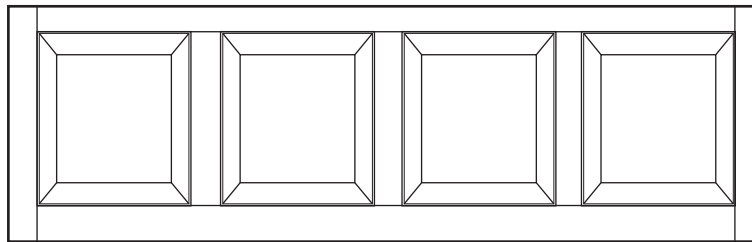
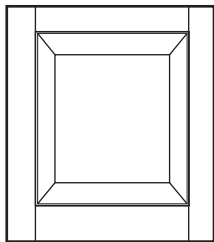

## Specialty Doors

Special doors are available with different size stiles and rails and or locations, or with special glass grids or grid locations, or with lower panels and upper glass with mullions. Please provide a sketch or a drawing.

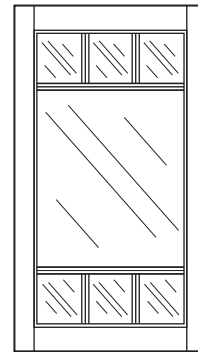
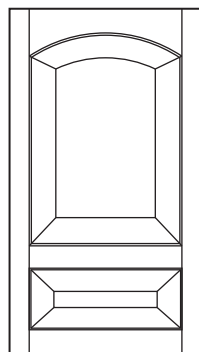
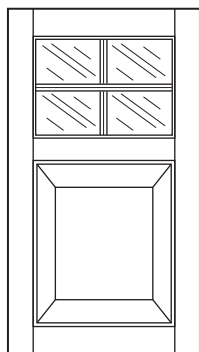

# INSIDE PROFILES

# Inside Stile & Rail Profiles

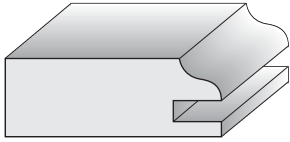

**1**

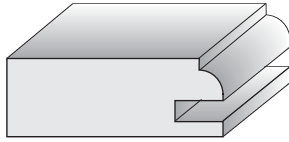

**2**

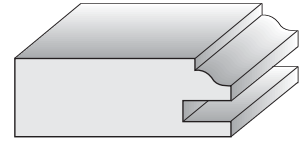

**3**

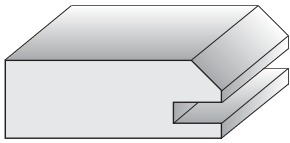

**4**

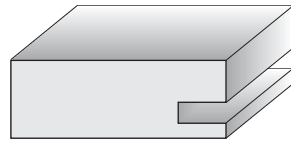

**5**

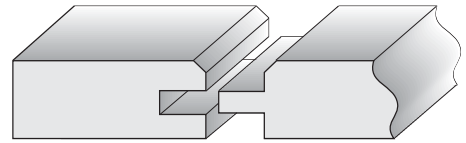

**6**

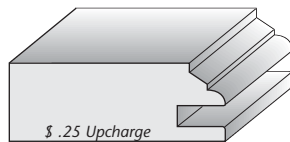

**7**

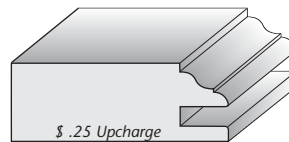

**8**

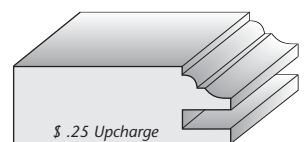

**9**

# **RAISED PANEL PROFILES**

# Raised Panel Profiles

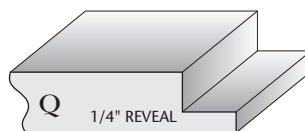
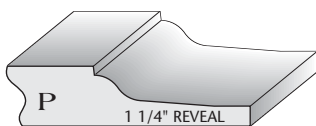
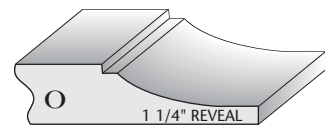
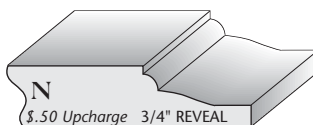
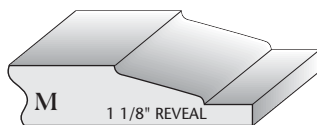
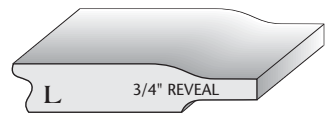
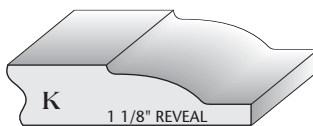
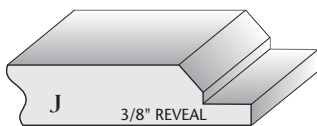
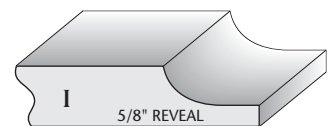
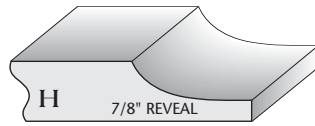
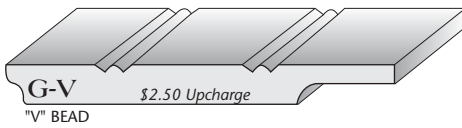
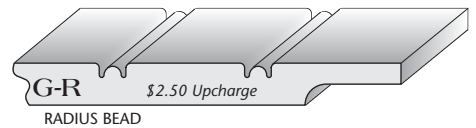
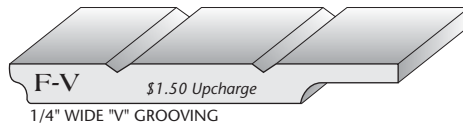
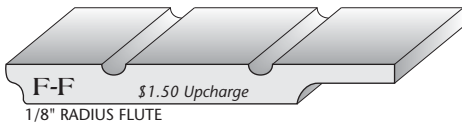
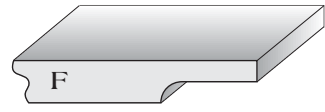
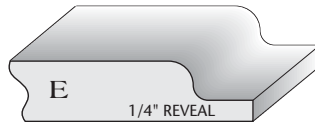
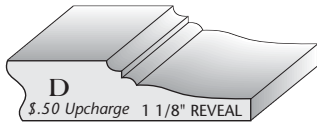
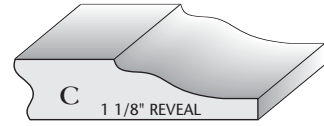
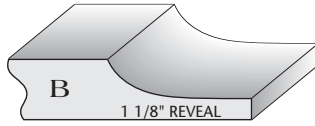
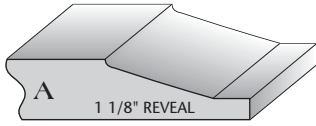

Beading and Grooving is on 1 1/2" Centers

# OUTSIDE PROFILES

# Outside Edge Profiles

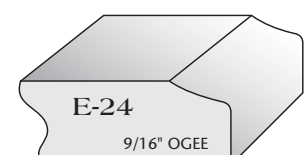
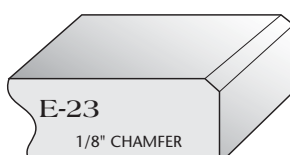
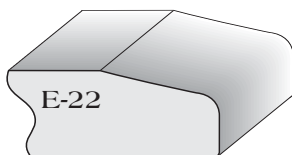
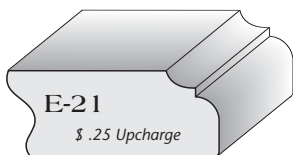
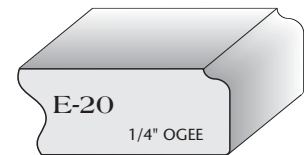
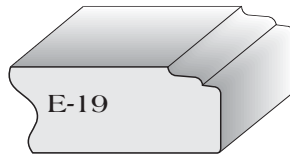
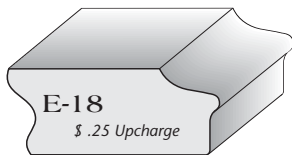
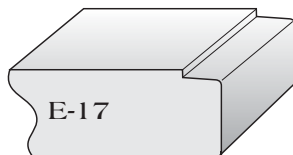
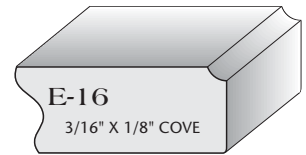
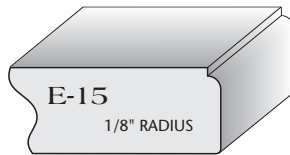
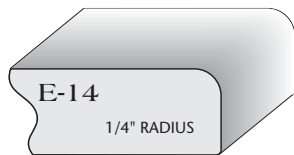
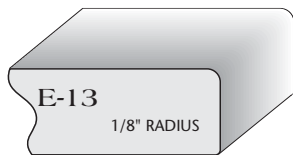
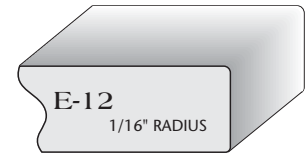
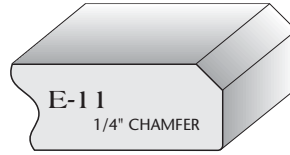
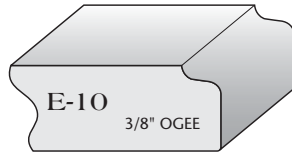
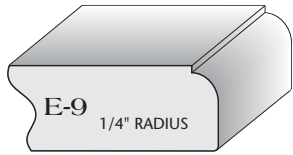
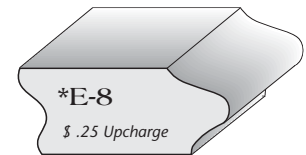
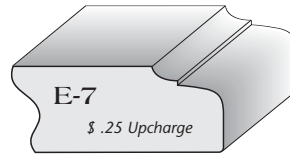
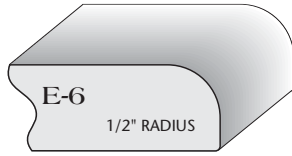
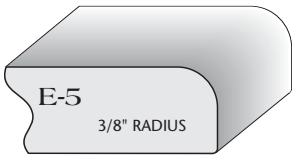
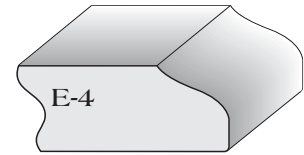
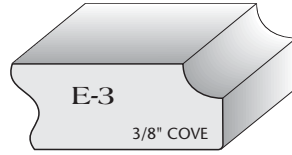
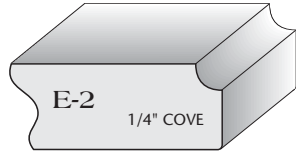
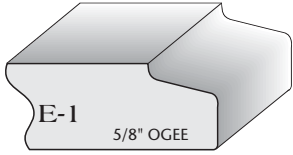

\*Not for use with 35mm Hinge Boring



# **BACK EDGE PROFILES**

# Back Edge Profiles

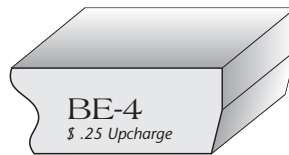
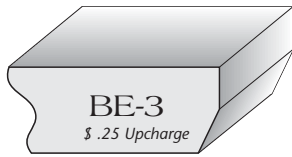
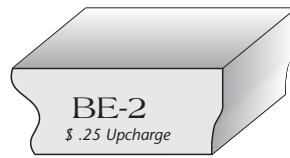
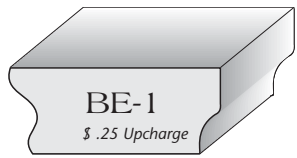

\*BE-1, BE-3 not for use with 35mm Hinge Boring

# **RAISED PANEL DOORS**

# Raised Panel Doors

2 1/4" Frame

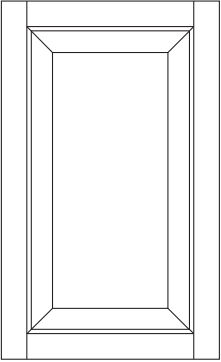

1100

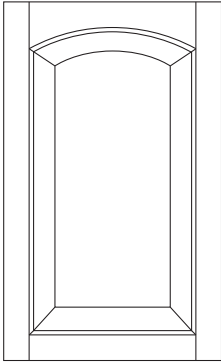

1200

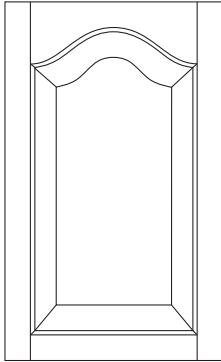

1300

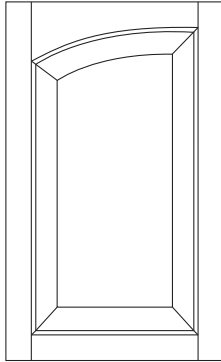

1600L

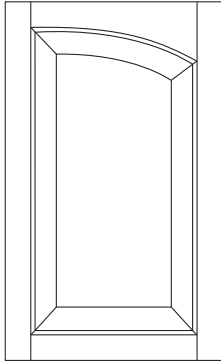

1600R

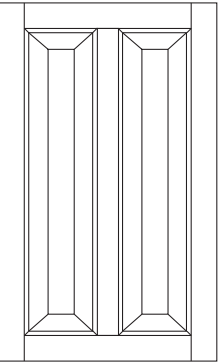

4500

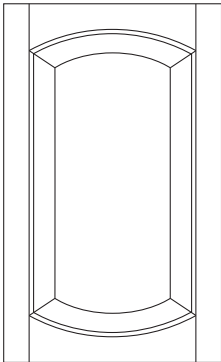

1400

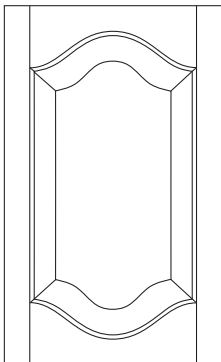

1500

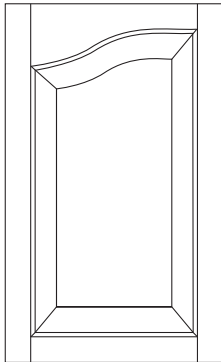

1700L

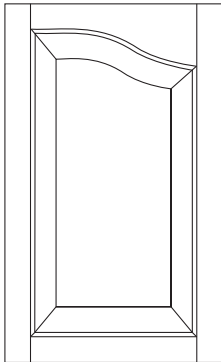

1700R

Call for current pricing

*All Prices Per Square Foot - Outside Edging Not Included*

# Raised Panel Doors

**2 1/4" Frame 3" Btm Rail**

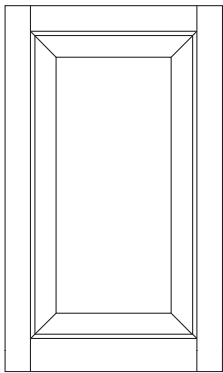

1150

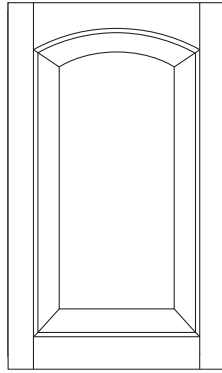

1250

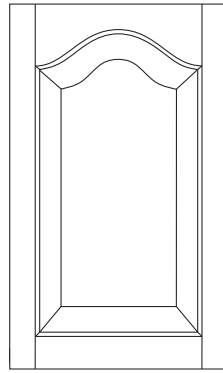

1350

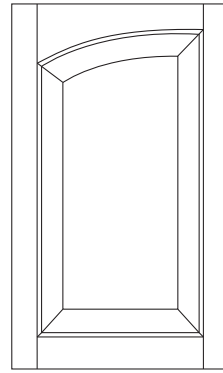

1650L

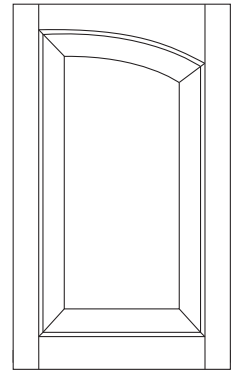

1650R

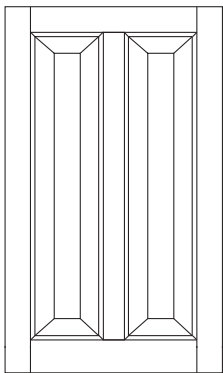

4550

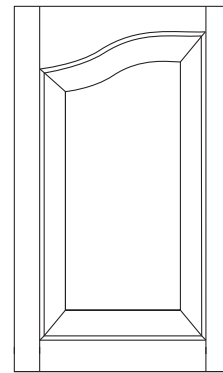

1750L

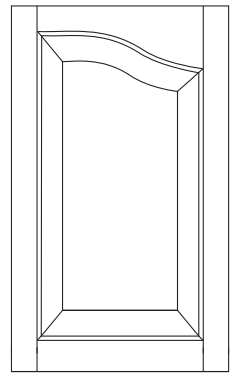

1750R

Call for current pricing

*All Prices Per Square Foot - Outside Edging Not Included*

# Raised Panel Doors

2 1/2" Frame

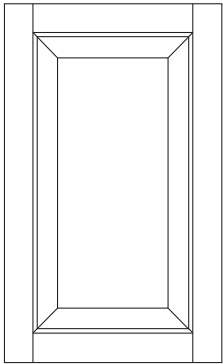

1120

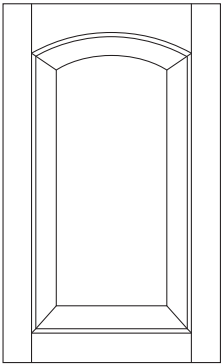

1220

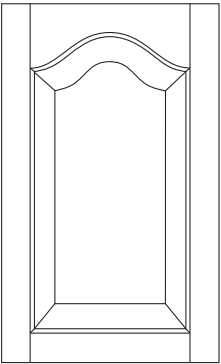

1320

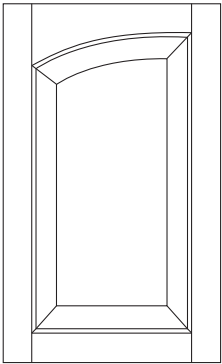

1620L

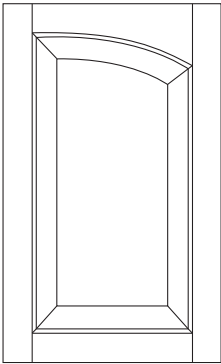

1620R

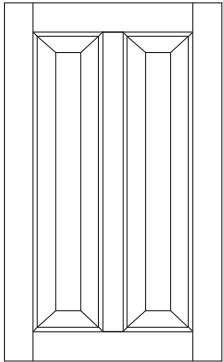

4520

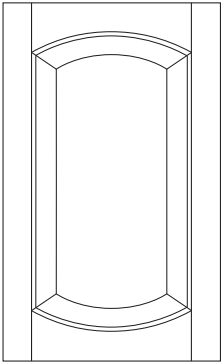

1420

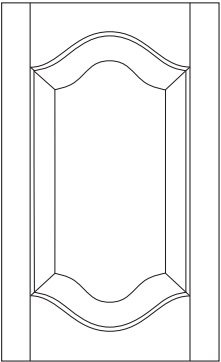

1520

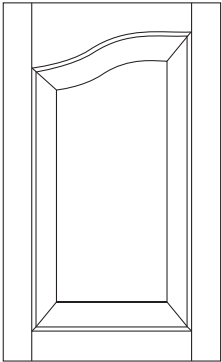

1720L

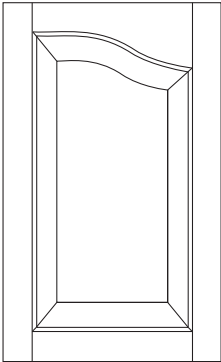

1720R

Call for current pricing

All Prices Per Square Foot - Outside Edging Not Included

# Raised Panel Doors

**2 1/2" Frame 3 1/4" Btm Rail**

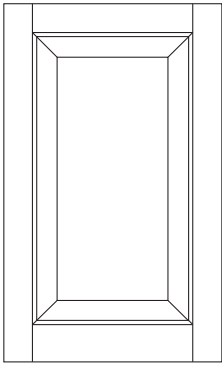

1170

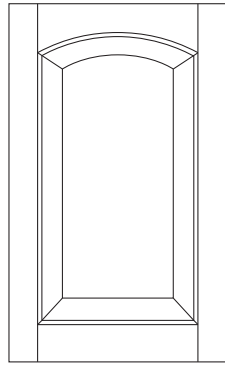

1270

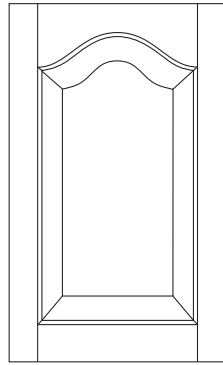

1370

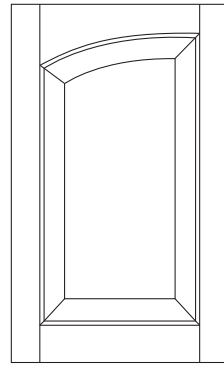

1670L

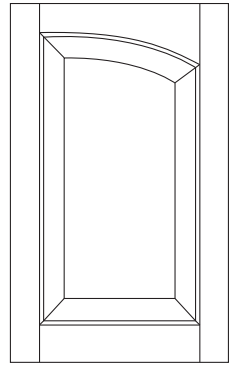

1670R

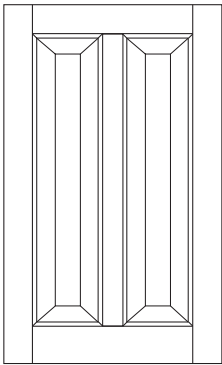

4570

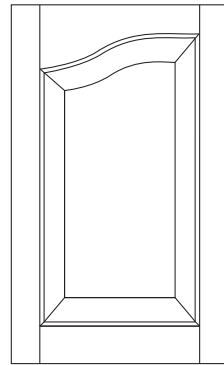

1770L

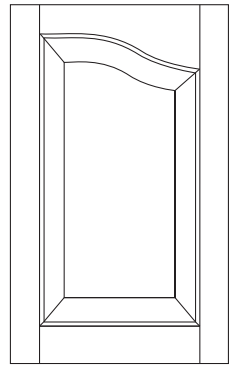

1770R

Call for current pricing

*All Prices Per Square Foot - Outside Edging Not Included*

# Raised Panel Doors

## 3" Frame

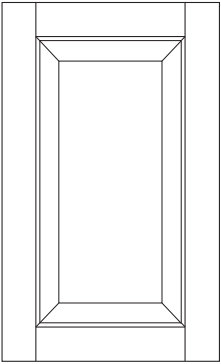

1130

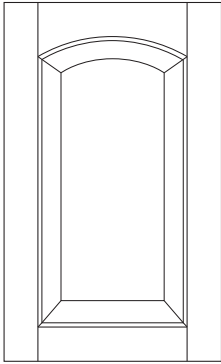

1230

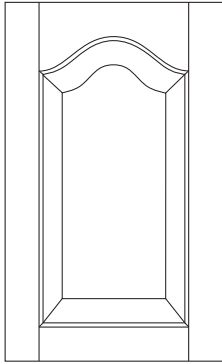

1330

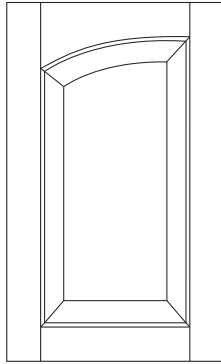

1630L

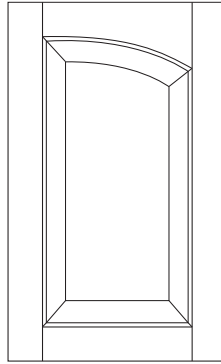

1630R

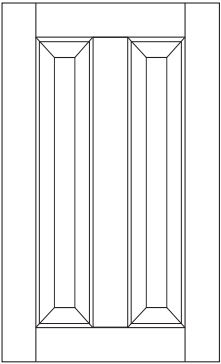

4530

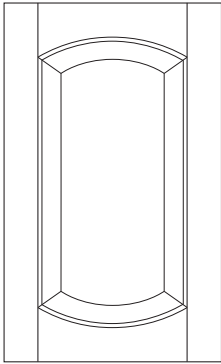

1430

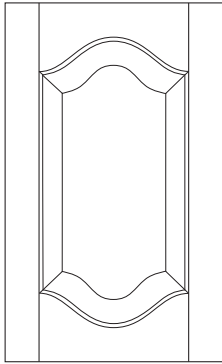

1530

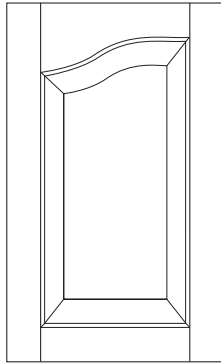

1730L

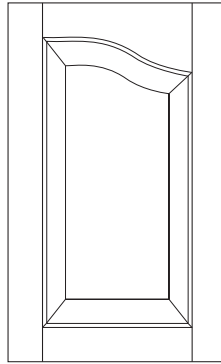

1730R

Call for current pricing

*All Prices Per Square Foot - Outside Edging Not Included*



# **RAISED PANEL DRAWER FRONTS**

# Raised Panel Drawer Fronts

## 2 1/4" Frame

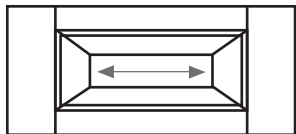

Raised Panel 1105

## 2 1/2" Frame

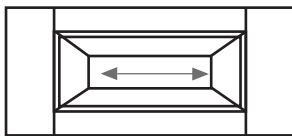

Raised Panel 1125

## 3" Frame

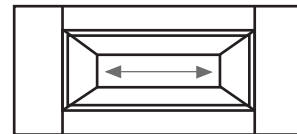

Raised Panel 1135

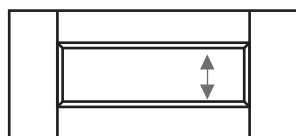

Reversed Raised Panel 1107



Reversed Raised Panel 1127

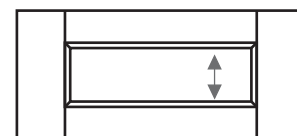

Reversed Raised Panel 1137

- *Raised panel drawer front rails are 1 1/4" wide*
  - *Reversed Raised (Profiles F or G series) panel drawer front rails are 1 3/4" wide*
  - *Raised panel drawer front grain direction will be horizontal except for raised panel profiles F and G*

Call for current pricing

# **RECESSED PANEL DOORS**

# Recessed Panel Doors

## 2 1/4" Frame

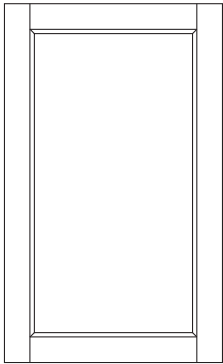

2100

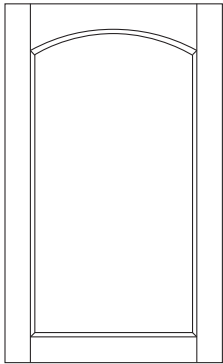

2200

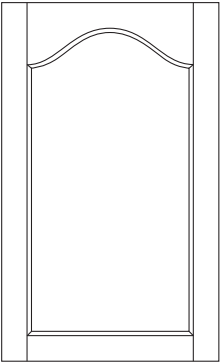

2300

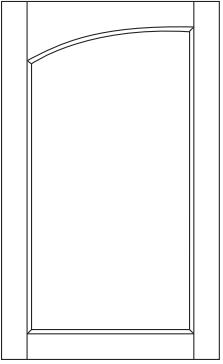

2600L

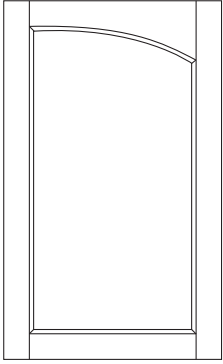

2600R

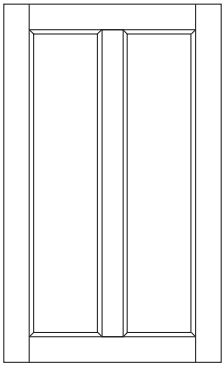

5500

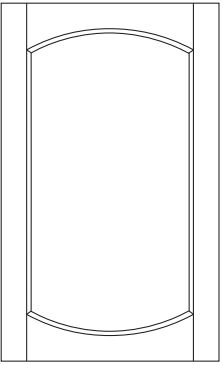

2400

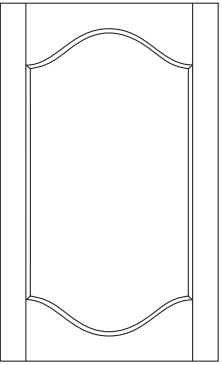

2500

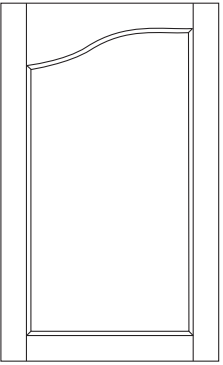

2700L

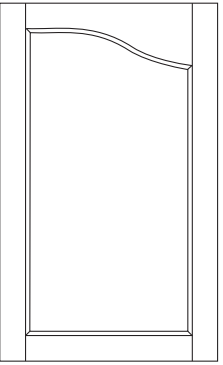

2700R

Call for current pricing

(PS) - Plain Sliced  
(RC) - Rotary Cut

(WPF) - Whole Piece Face  
\* Red Birch Plywood Panel

All Prices Per Square Foot - Outside Edging Not Included

# Recessed Panel Doors

2 1/4" Frame 3" Btm Rail

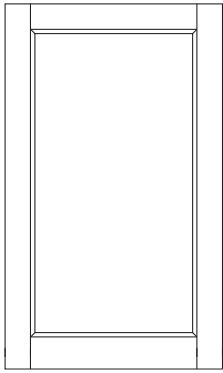

2150

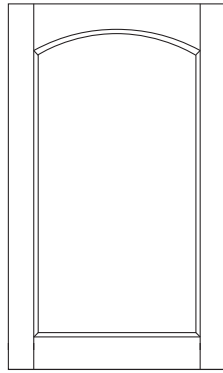

2250

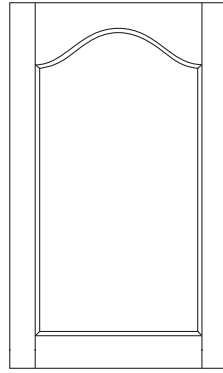

2350

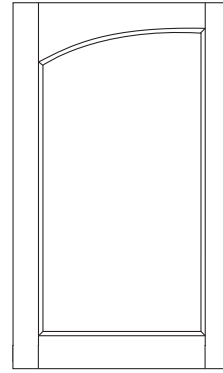

2650L

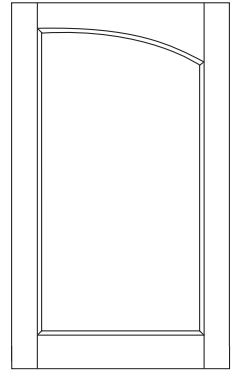

2650R

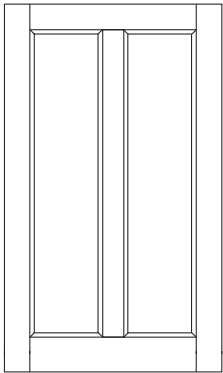

5550

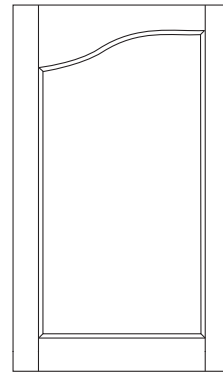

2750L

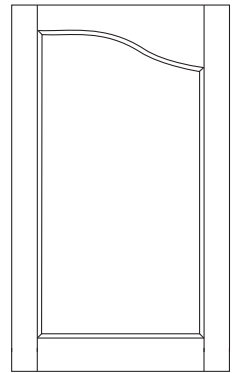

2750R

Call for current pricing

(PS) - Plain Sliced  
(RC) - Rotary Cut

(WPF) - Whole Piece Face  
\* Red Birch Plywood Panel

All Prices Per Square Foot - Outside Edging Not Included

# Recessed Panel Doors

## 2 1/2" Frame

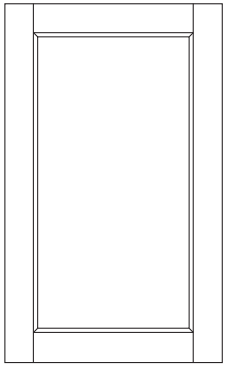

2120

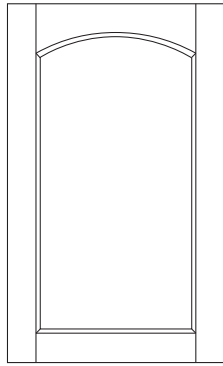

2220

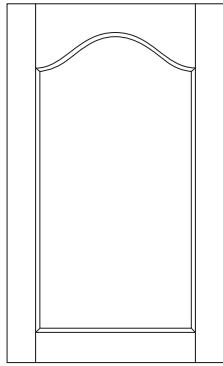

2320

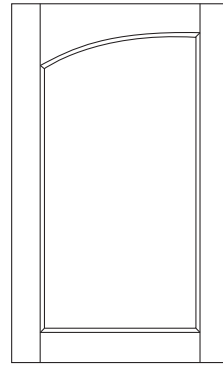

2620L

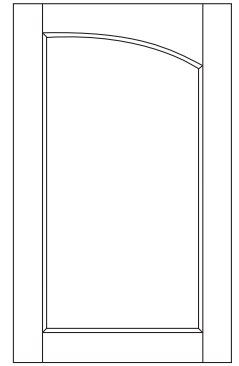

2620R

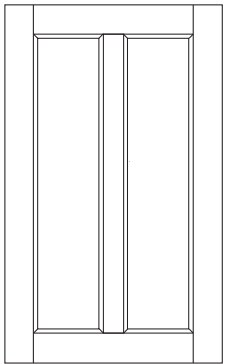

5520

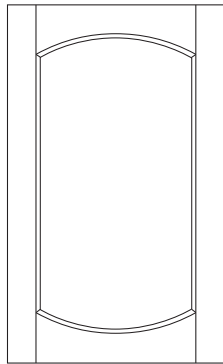

2420

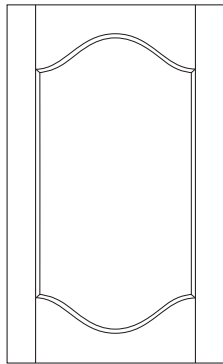

2520

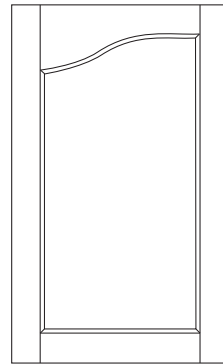

2720L

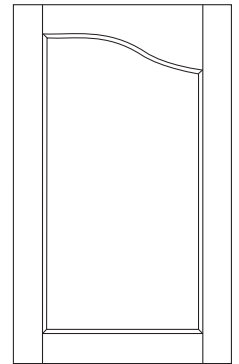

2720R

Call for current pricing

# Recessed Panel Doors

**2 1/2" Frame    3 1/4" Btm Rail**

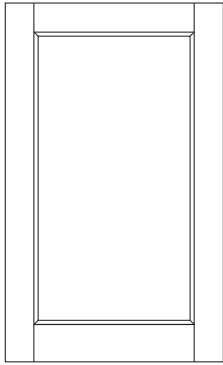

2170

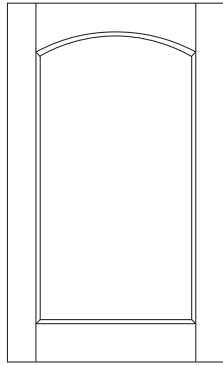

2270

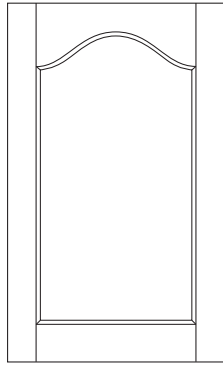

2370

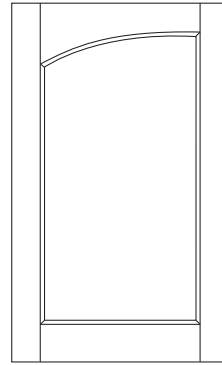

2670L

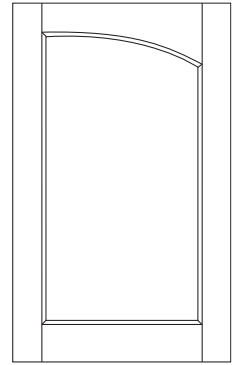

2670R

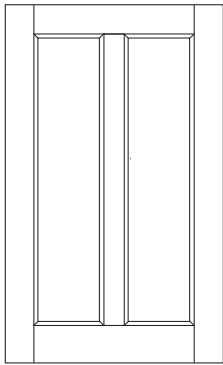

5570

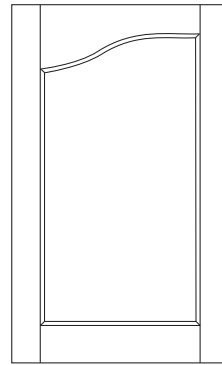

2770L

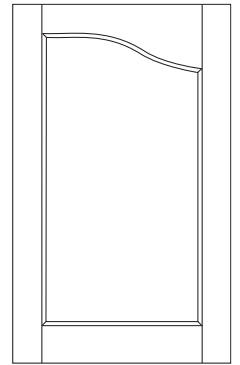

2770R

Call for current pricing

(PS) - Plain Sliced  
(RC) - Rotary Cut

(WPF) - Whole Piece Face  
\* Red Birch Plywood Panel

All Prices Per Square Foot - Outside Edging Not Included

# Recessed Panel Doors

## 3" Frame

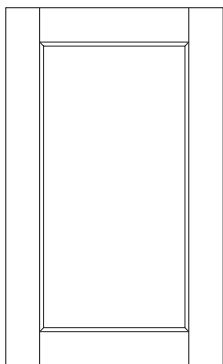

2130

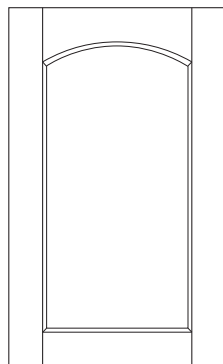

2230

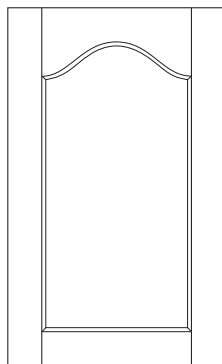

2330

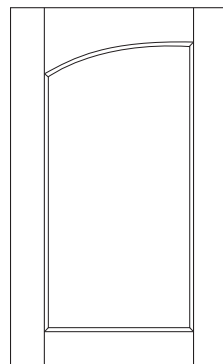

2630L

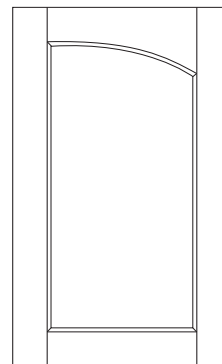

2630R

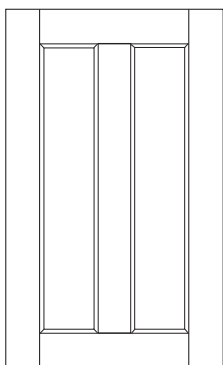

5530

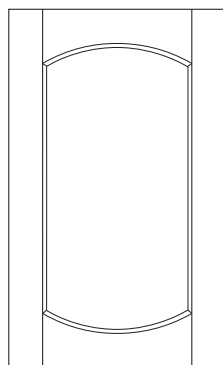

2430

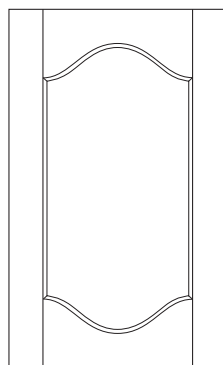

2530

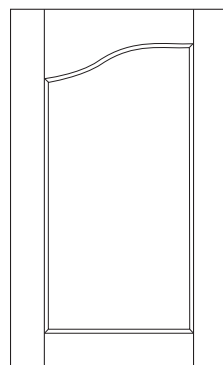

2730L

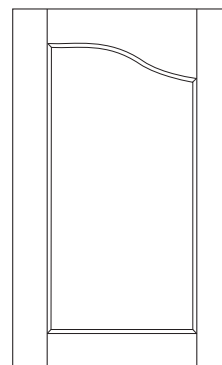

2730R

Call for current pricing



# **RECESSED PANEL DRAWER FRONTS**

# Recessed Panel Drawer Fronts

## 2 1/4" Frame



Recessed Panel 2105

## 2 1/2" Frame



Recessed Panel 2125

## 3" Frame

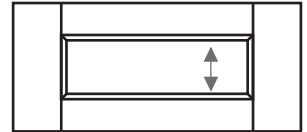

Recessed Panel 2135

- Recessed panel drawer front rails are 1-3/4" wide. Other widths available upon request.
- Recessed panel drawer front grain direction is vertical. Horizontal grain direction available upon request.

Call for current pricing

(PS) - Plain Sliced  
(RC) - Rotary Cut

(WPF) - Whole Piece Face  
\* Red Birch Plywood Panel

All Prices Per Square Foot - Outside Edging Not Included

# GLASS FRAME DOORS

# Glass Frame Doors

## 2 1/4" Frame

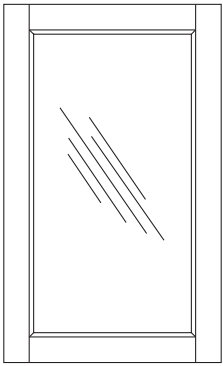

3100

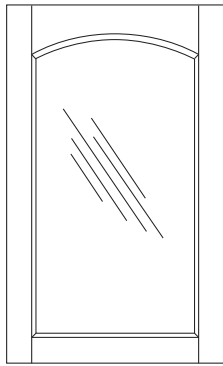

3200

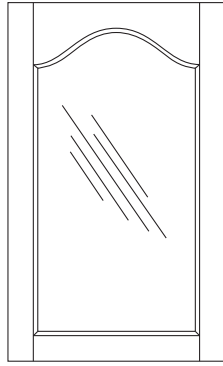

3300

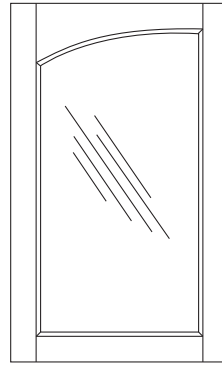

3600L

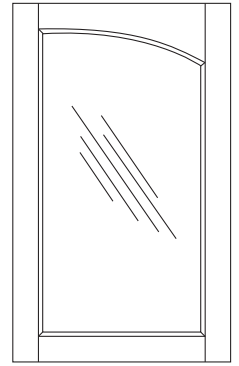

3600R

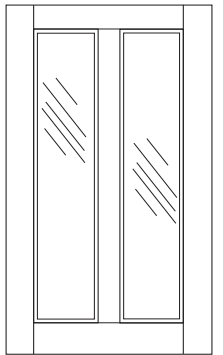

5500G

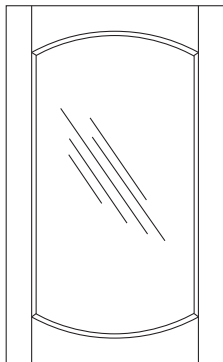

3400

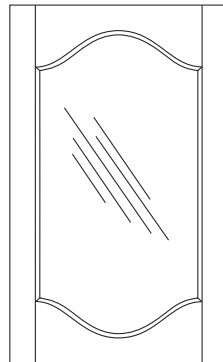

3500

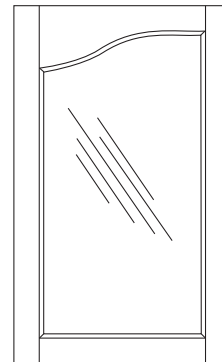

3700L

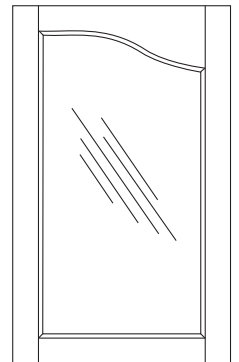

3700R

## Call for current pricing

*All Prices Per Square Foot - Outside Edging Not Included - Glass and Stops Not Included*

# Glass Frame Doors

**2 1/4" Frame 3" Btm Rail**

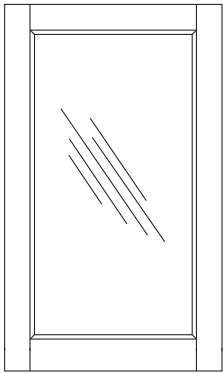

3150

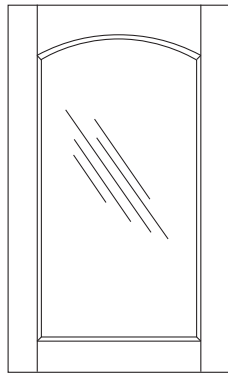

3250

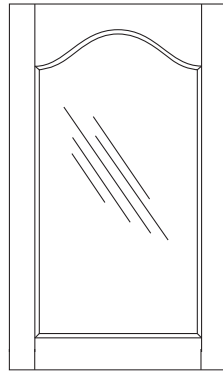

3350

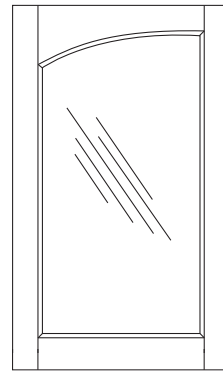

3650L

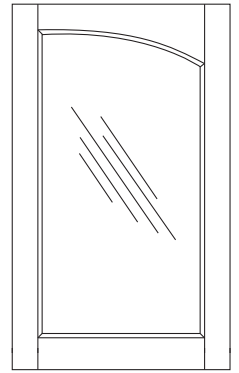

3650R

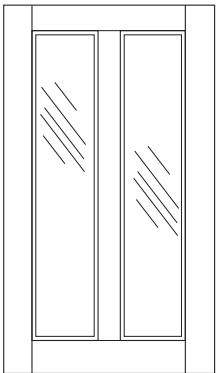

5550G

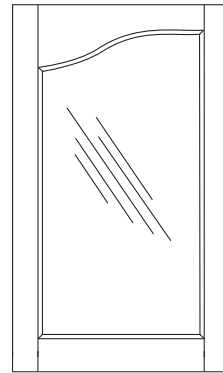

3750L

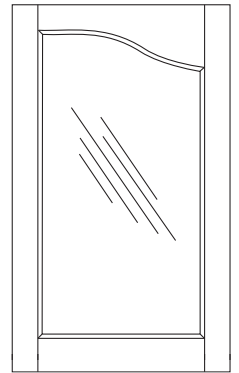

3750R

Call for current pricing

*All Prices Per Square Foot - Outside Edging Not Included - Glass and Stops Not Included*

# Glass Frame Doors

## 2 1/2" Frame

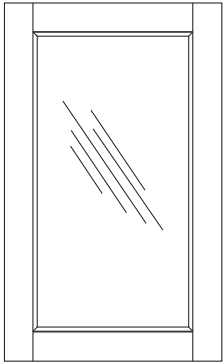

3120

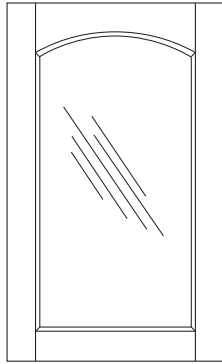

3220

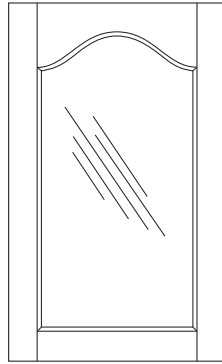

3320

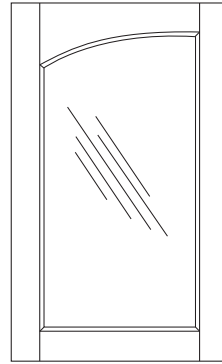

3620L

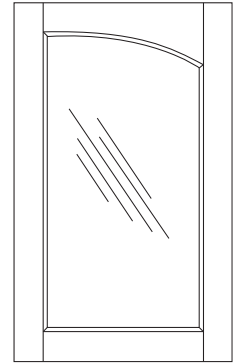

3620R

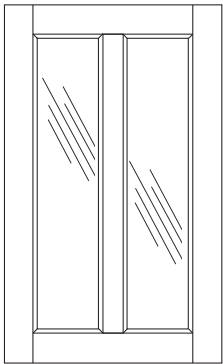

5520G

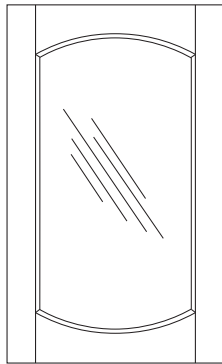

3420

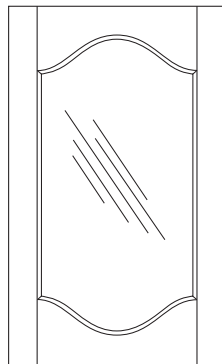

3520

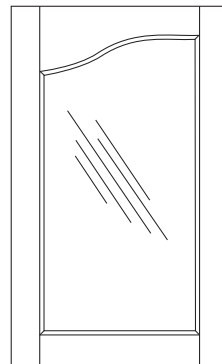

3720L

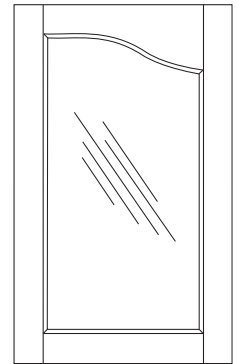

3720R

## Call for current pricing

*All Prices Per Square Foot - Outside Edging Not Included - Glass and Stops Not Included*

# Glass Frame Doors

2 1/2" Frame 3 1/4" Btm Rail

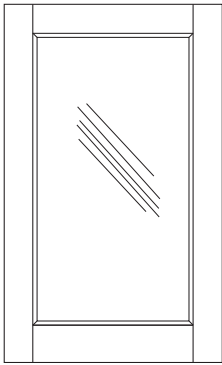

3170

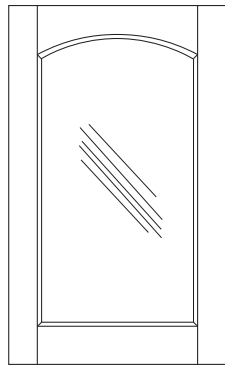

3270

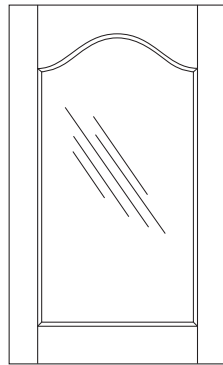

3370

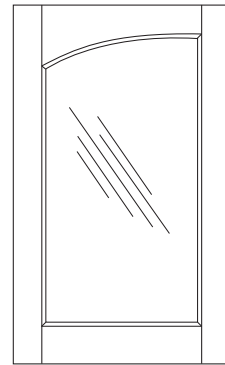

3670L

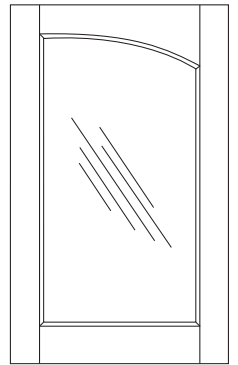

3670R

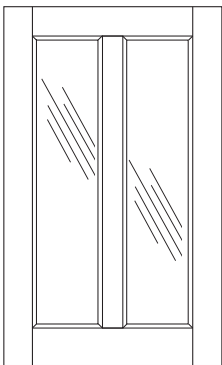

5570G

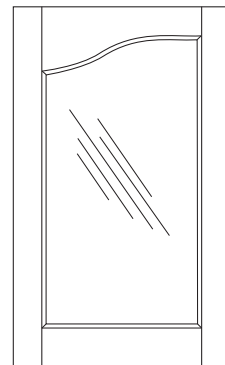

3770L

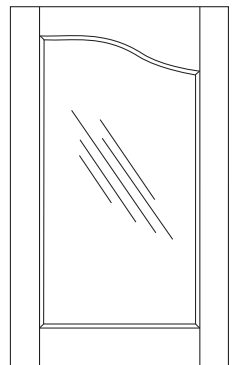

3770R

Call for current pricing

*All Prices Per Square Foot - Outside Edging Not Included - Glass and Stops Not Included*

# Glass Frame Doors

## 3" Frame

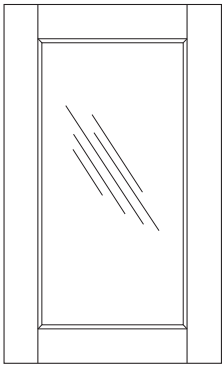

3130

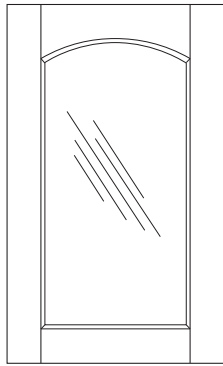

3230

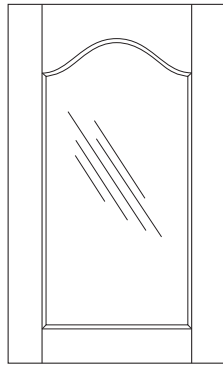

3330

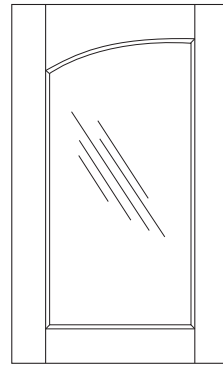

3630L

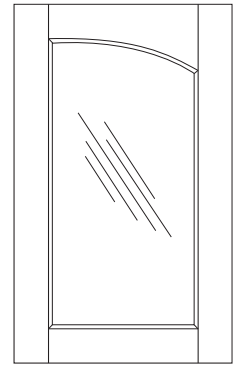

3630R

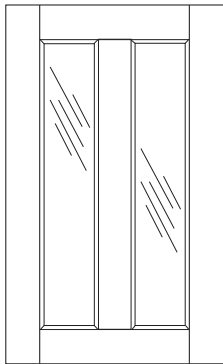

5530G

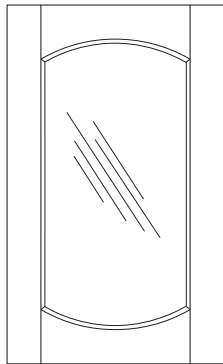

3430

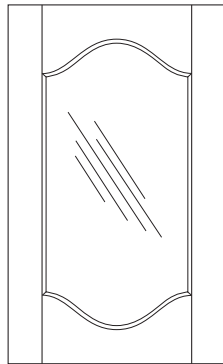

3530

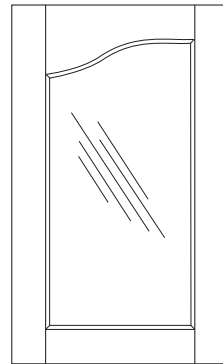

3730L

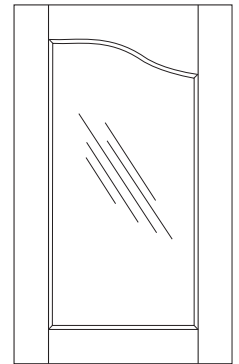

3730R

Call for current pricing

*All Prices Per Square Foot - Outside Edging Not Included - Glass and Stops Not Included*



# **GLASS MULLION DOORS**

# Glass Mullion Doors

## 2 1/4" Frame

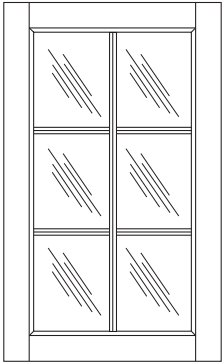

3100-6

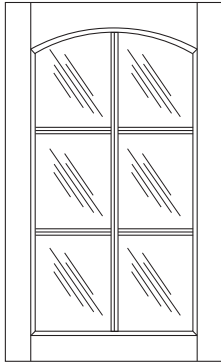

3200-6

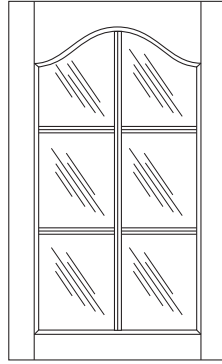

3300-6

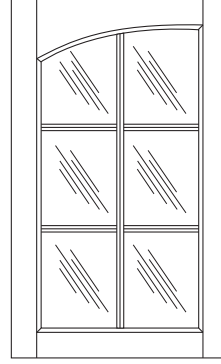

3600L/R-6

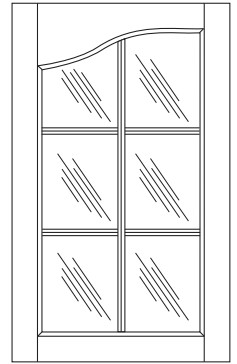

3700L/R-6

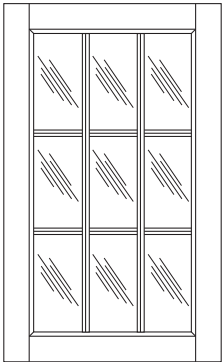

3100-9

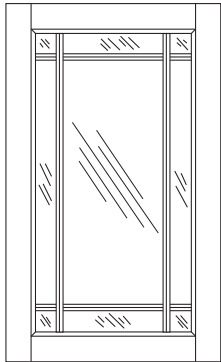

3100-9S

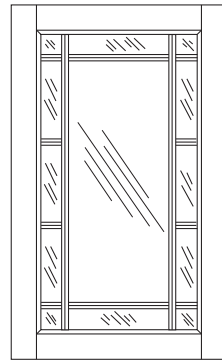

3100-13S

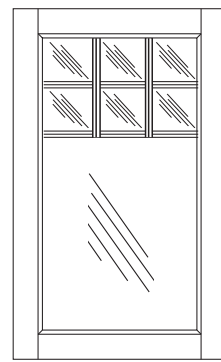

3100-7S

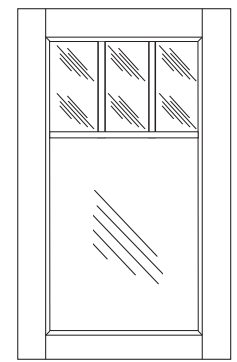

3100-4S

Call for current pricing

*Specify number of lites by adding a dash-number to door style number (3100-8 has 8 lites).  
All Prices Per Square Foot - Outside Edging Not Included - Glass and Stops Not Included*

# Glass Mullion Doors

2 1/4" Frame 3" Btm Rail

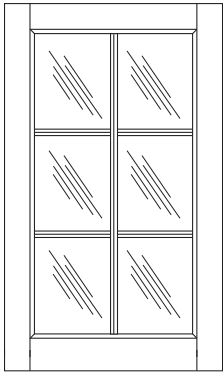

3150-6

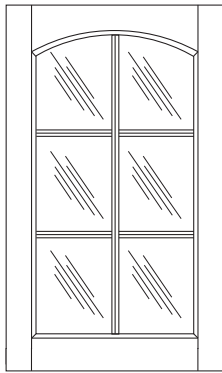

3250-6

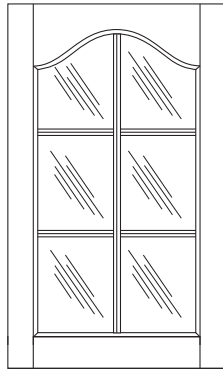

3350-6

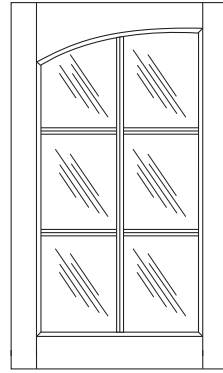

3650L/R-6

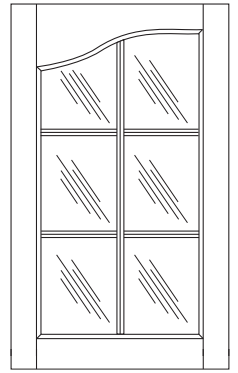

3750L/R-6

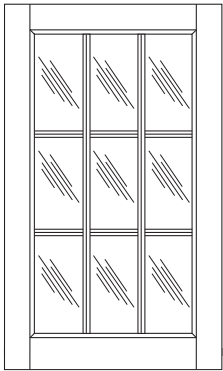

3150-9

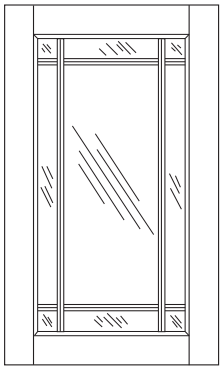

3150-9S

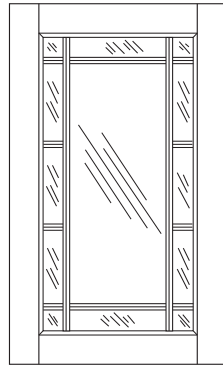

3150-13S

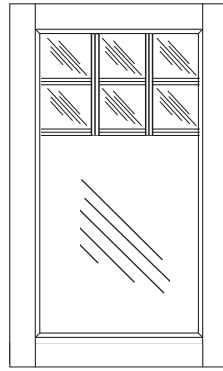

3150-7S

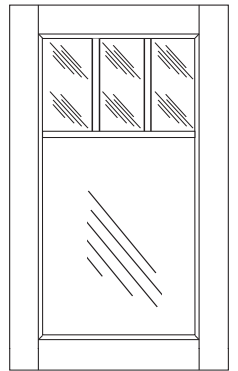

3150-4S

## Call for current pricing

*Specify number of lites by adding a dash-number to door style number (3150-8 has 8 lites).  
All Prices Per Square Foot - Outside Edging Not Included - Glass and Stops Not Included*

# Glass Mullion Doors

## 2 1/2" Frame

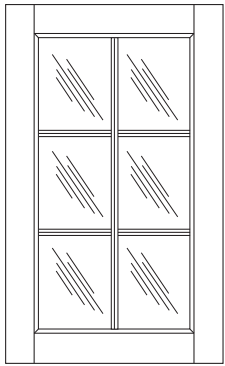

3120-6

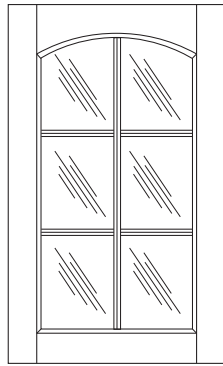

3220-6

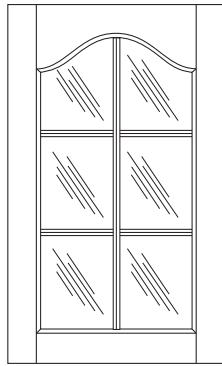

3320-6

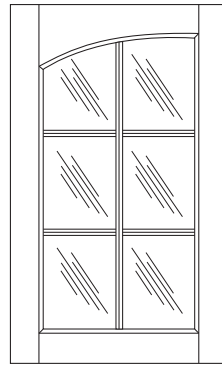

3620L/R-6

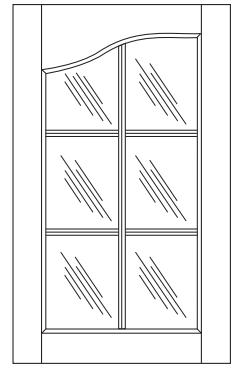

3720L/R-6

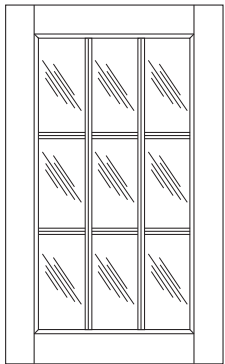

3120-9

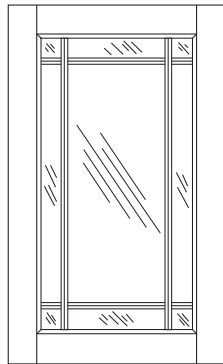

3120-9S

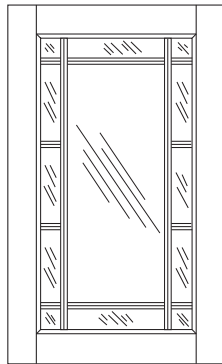

3120-13S

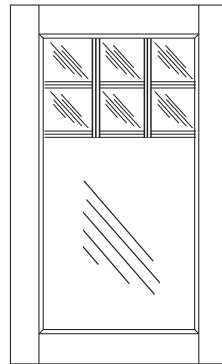

3120-7S

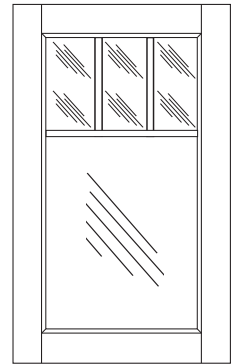

3120-4S

Call for current pricing

*Specify number of lites by adding a dash-number to door style number (3120-8 has 8 lites).  
All Prices Per Square Foot - Outside Edging Not Included - Glass and Stops Not Included*

# Glass Mullion Doors

2 1/2" Frame 3 1/4" Btm Rail

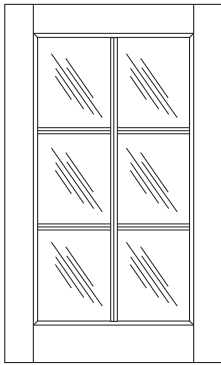

3170-6

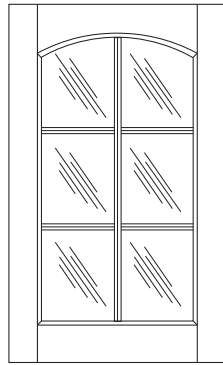

3270-6

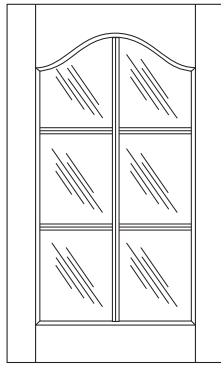

3370-6

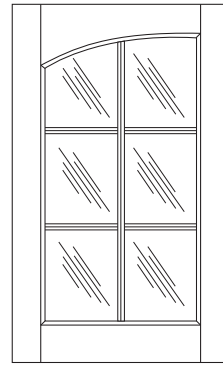

3670L/R-6

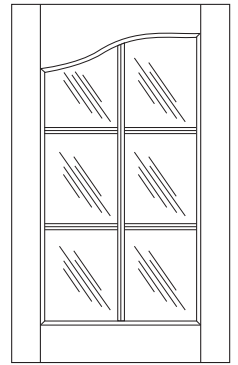

3770L/R-6

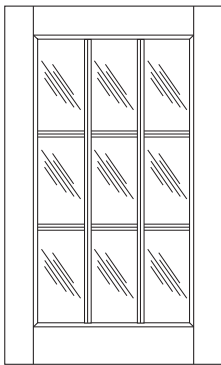

3170-9

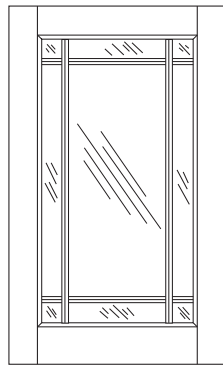

3170-9S

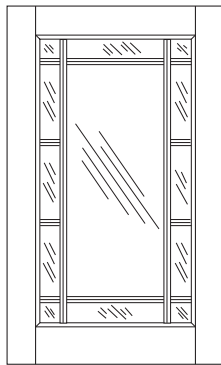

3170-13S

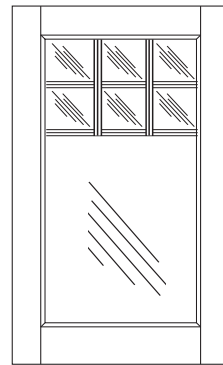

3170-7S

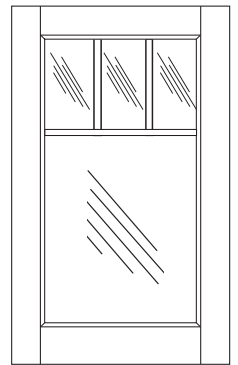

3170-4S

## Call for current pricing

*Specify number of lites by adding a dash-number to door style number (3170-8 has 8 lites).  
All Prices Per Square Foot - Outside Edging Not Included - Glass and Stops Not Included*

# Glass Mullion Doors

## 3" Frame

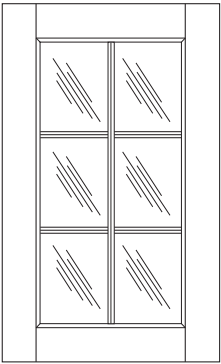

3130-6

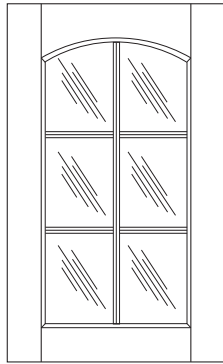

3230-6

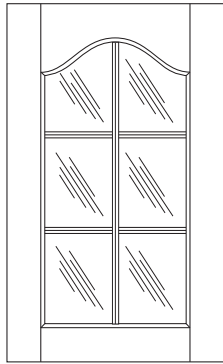

3330-6

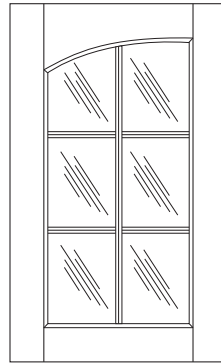

3630L/R-6

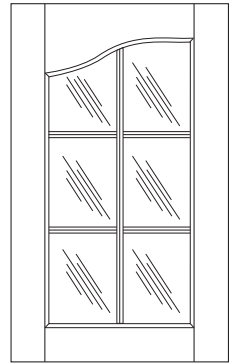

3730L/R-6

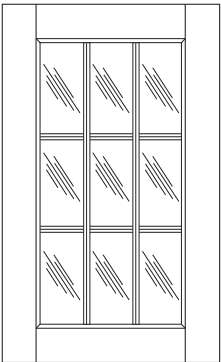

3130-9

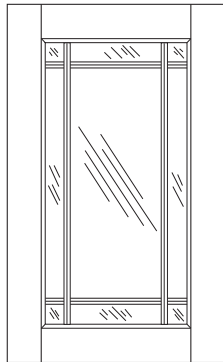

3130-9S

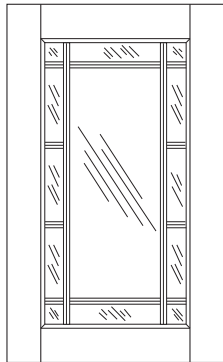

3130-13S

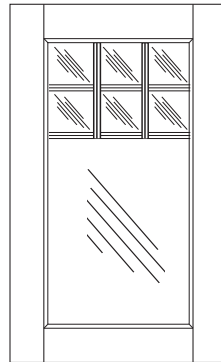

3130-7S

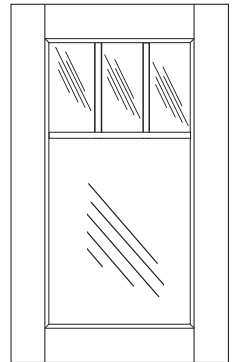

3130-4S

# Call for current pricing

*Specify number of lites by adding a dash-number to door style number (3130-8 has 8 lites).  
All Prices Per Square Foot - Outside Edging Not Included - Glass and Stops Not Included*

# **MITERED DOOR PROFILES**

# Mitered Door Frame Profiles

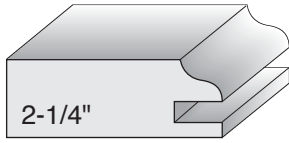

**M1**  
**M1-2-1/2"**  
**M1-3"**

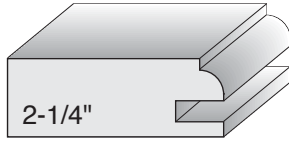

**M2**  
**M2-2-1/2"**  
**M2-3"**

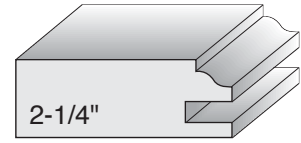

**M3**  
**M3-2-1/2"**  
**M3-3"**

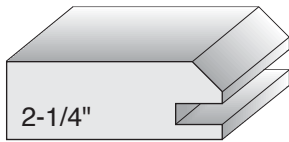

**M4**  
**M4-2-1/2"**  
**M4-3"**

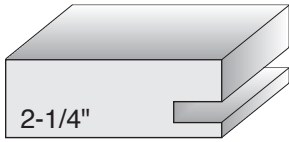

**M5**  
**M5-2-1/2"**  
**M5-3"**

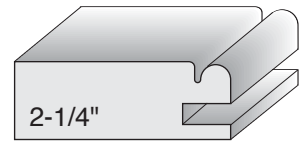

**M6**  
**M6-2-1/2"**  
**M6-3"**

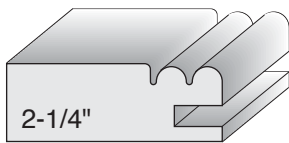

**M7**  
**M7-2-1/2"**  
**M7-3"**

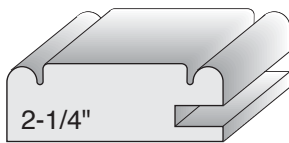

**M8**  
**M8-2-1/2"**

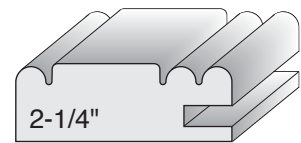

**M9**

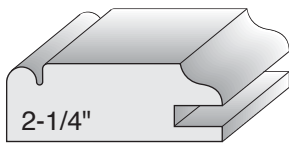

**M10**  
**M10-2-1/2"**  
**M10-3"**

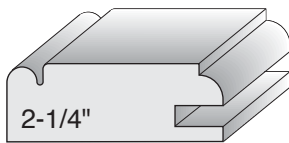

**M11**  
**M11-2-1/2"**  
**M11-3"**

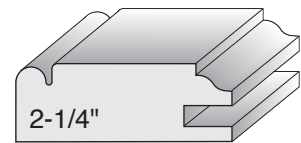

**M12**  
**M12-2-1/2"**  
**M12-3"**

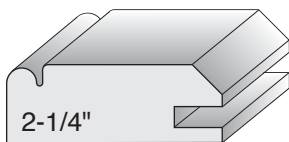

**M13**  
**M13-2-1/2"**  
**M13-3"**

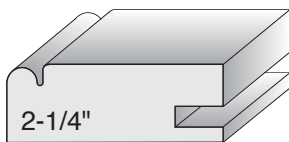

**M14**  
**M14-2-1/2"**  
**M14-3"**

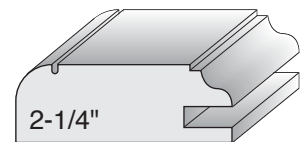

**M15**

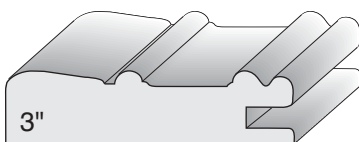

**M16**

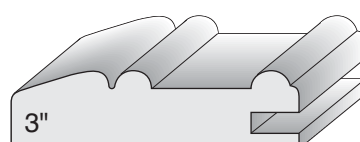

**M17**

*Standard Outside Edges can be applied to profiles M1 thru M7, M19, M25 thru M29, M31 & M32*



# Mitered Door Frame Profiles

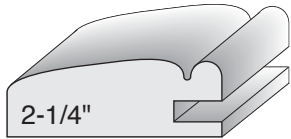

**M18**  
**M18-2-1/2"**  
**M18-3"**

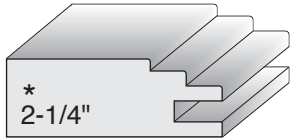

**M19**  
**M19-2-1/2"**  
**M19-3"**

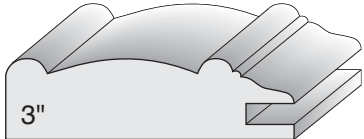

**M20**  
**M20-2-1/4"**  
**M20-2-1/2"**

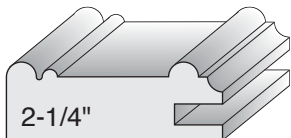

**M21**



**M22**

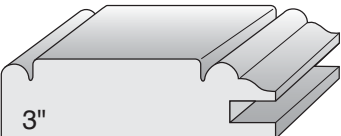

**M23**

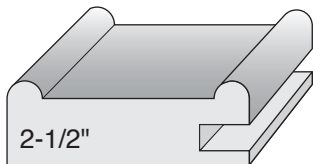

**M24**

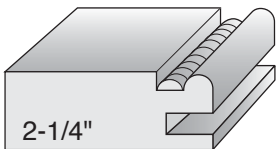

**M25**  
**M25-2-1/2"**  
**M25-3"**

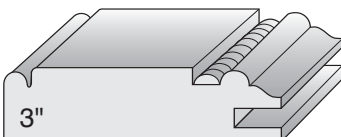

**M26**

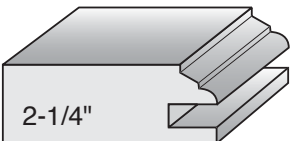

**M27**  
**M27-2-1/2"**  
**M27-3"**

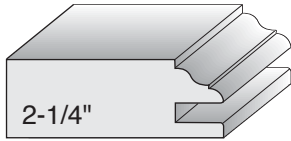

**M28**  
**M28-2-1/2"**  
**M28-3"**

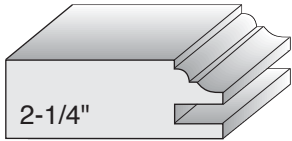

**M29**  
**M29-2-1/2"**  
**M29-3"**

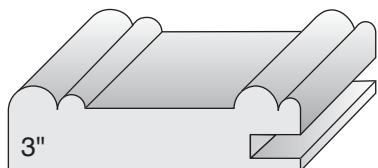

**M30**

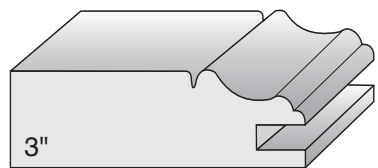

**M31**

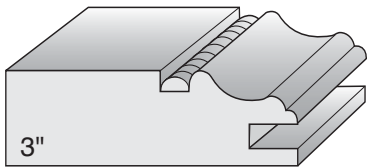

**M32**

*\* Used with edge E-17  
 Standard Outside Edges can be applied to profiles M1 thru M7, M19, M25 thru M29, M31 & M32*



# **MITTERED RAISED PANEL DOORS**

# Mitered Raised Panel Doors

## 2 1/4" Frame

## 2 1/2" Frame

## 3" Frame

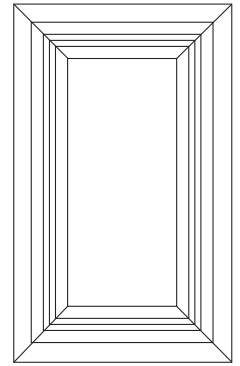
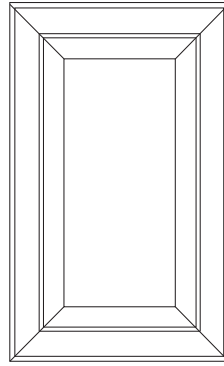
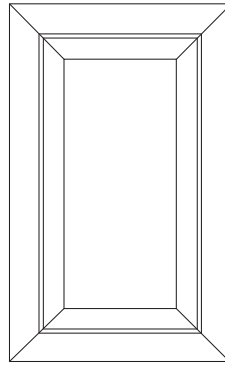
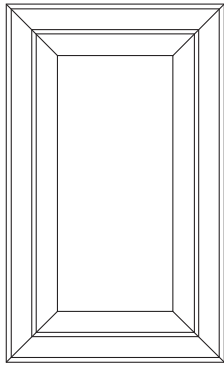
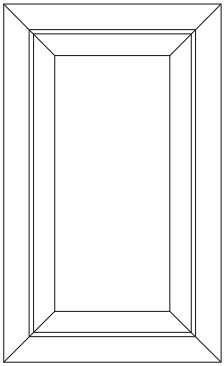

7000  
7000RM\*

7010

7050  
7050RM\*

7060

7020  
7020RM\*

7000	Profiles:	M1, M2, M3, M4, M5, M6, M7, M19, M27, M28, & M29
7010	Profiles:	M8, M9, M10, M11, M12, M13, M14, M15, M18, M20-2 1/2 & M21
7050	Profiles:	M1-2 1/2, M2-2 1/2, M3-2 1/2, M4-2 1/2, M5-2 1/2, M6-2 1/2, M7-2 1/2 M19-2 1/2, M27-2 1/2, M28-2 1/2 & M29-2 1/2
7060	Profiles:	M8-2 1/2, M10-2 1/2, M11-2 1/2, M12-2 1/2, M13-2 1/2, M14-2 1/2, M18-2 1/2, M20-2 1/2, & M24
7020	Profiles:	M1-3, M2-3, M3-3, M4-3, M5-3, M6-3, M7-3, M10-3, M11-3, M12-3, M13-3, M14-3, M16, M17, M18-3, M19-3, M20, M22, M23, M27-3, M28-3, M29-3, M30 & M31
7000RM	Profiles:	M25
7050RM	Profiles:	M25-2 1/2
7020RM	Profiles:	M25-3, M26 & M32

- Standard outside edges are available on 7000 series mitered doors with Profiles: M1 thru M7, M19, M25 thru M29, M31 & M32.
- Center Rails and/or Center Stiles are available on mitered doors with Profiles: M1 thru M5, M10 thru M14 & M27 thru M29.

Call for current pricing

\* Rope Molding Door

All Prices Per Square Foot - Outside Edging for 7000 & 7050 Series Doors Not Included

# **MITTERED RECESSED PANEL DOORS**

# Mitered Recessed Panel Doors

## 2 1/4" Frame

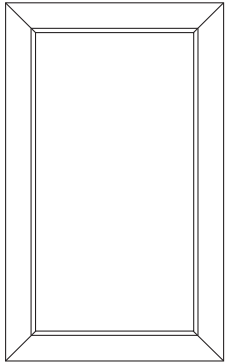

7100  
7100RM\*\*

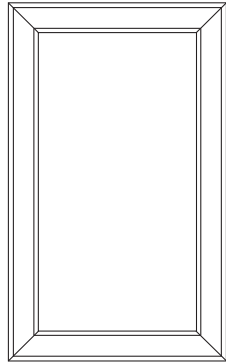

7110

## 2 1/2" Frame

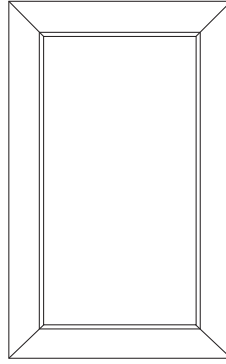

7150  
7150RM\*\*

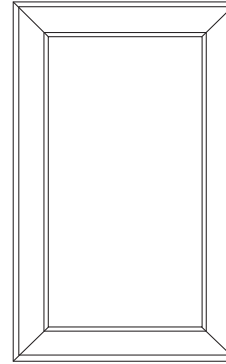

7160

## 3" Frame

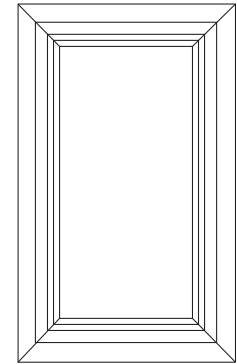

7120  
7120RM\*\*

7100	Profiles:	M1, M2, M3, M4, M5, M6, M7, M19, M27, M28, & M29
7110	Profiles:	M8, M9, M10, M11, M12, M13, M14, M15, M18, M20-2 1/2 & M21
7150	Profiles:	M1-2 1/2, M2-2 1/2, M3-2 1/2, M4-2 1/2, M5-2 1/2, M6-2 1/2, M7-2 1/2, M19-2 1/2, M27-2 1/2, M28-2 1/2 & M29-2 1/2.
7160	Profiles:	M8-2 1/2, M10-2 1/2, M11-2 1/2, M12-2 1/2, M13-2 1/2, M14-2 1/2, M18-2 1/2, M20-2 1/2, & M24
7120	Profiles:	M1-3, M2-3, M3-3, M4-3, M5-3, M6-3, M7-3, M10-3, M11-3, M12-3, M13-3, M14-3, M16, M17, M18-3, M19-3, M20, M22, M23, M27-3, M28-3, M29-3, M30 & M31
7100RM	Profiles:	M25
7150RM	Profiles:	M25-2 1/2
7120RM	Profiles:	M25-3, M26 & M32

- Standard outside edges are available on 7100 series mitered doors with Profiles: M1 thru M7, M19, M25 thru M29, M31 & M32.
- Center Rails and/or Center Stiles are available on mitered doors with Profiles: M1 thru M5, M10 thru M14 & M27 thru M29.

Call for current pricing

\* Red Birch Plywood Panel  
\*\* Rope Molding Door

All Prices Per Square Foot - Outside Edging for 7100 & 7150 Series Doors not included

# **MITERED GLASS DOORS**

# Mitered Glass Doors

## 2 1/4" Frame

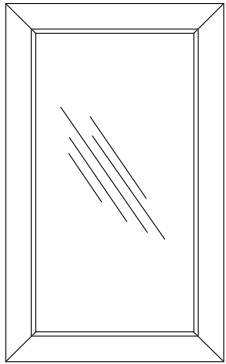

7200  
7200RM\*

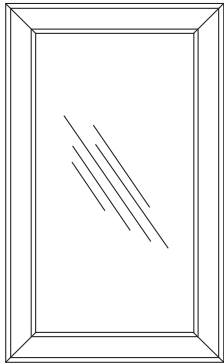

7210

## 2 1/2" Frame

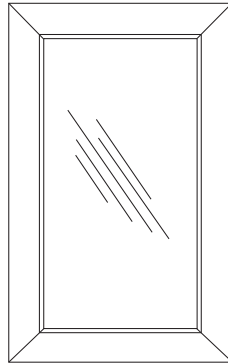

7250  
7250RM\*

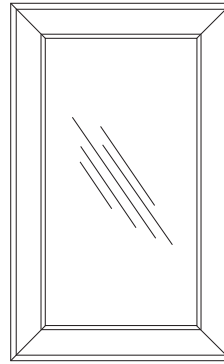

7260

## 3" Frame

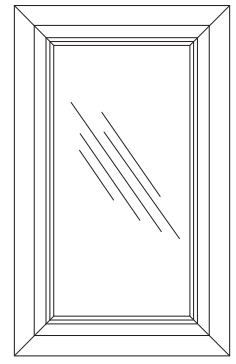

7220  
7220RM\*

7200	Profiles:	M1, M2, M3, M4, M5, M6, M7, M19, M27, M28, & M29
7210	Profiles:	M8, M9, M10, M11, M12, M13, M14, M15, M18, M20-2 1/2 & M21
7250	Profiles:	M1-2 1/2, M2-2 1/2, M3-2 1/2, M4-2 1/2, M5-2 1/2, M6-2 1/2, M7-2 1/2, M19-2 1/2, M27-2 1/2, M28-2 1/2 & M29-2 1/2
7260	Profiles:	M8-2 1/2, M10-2 1/2, M11-2 1/2, M12-2 1/2, M13-2 1/2, M14-2 1/2, M18-2 1/2, M20-2 1/2, & M24
7220	Profiles:	M1-3, M2-3, M3-3, M4-3, M5-3, M6-3, M7-3, M10-3, M11-3, M12-3, M13-3, M14-3, M16, M17, M18-3, M19-3, M20, M22, M23, M27-3, M28-3, M29-3, M30 & M31
7200RM	Profiles:	M25
7250RM	Profiles:	M25-2 1/2
7220RM	Profiles:	M25-3, M26 & M32

- Standard outside edges are available on 7200 series mitered doors with Profiles: M1 thru M7, M19, M25 thru M29, M31 & M32.

Call for current pricing

\* Rope Molding Door

All Prices Per Square Foot - Outside Edging for 7200 & 7250 Series Doors Not Included



# **MITERED GLASS MULLION DOORS**

# Mitered Glass Mullion Doors

## 2 1/4" Frame

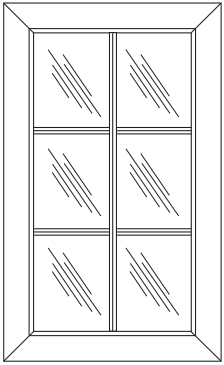

7200-6

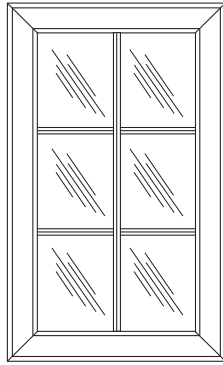

7210-6

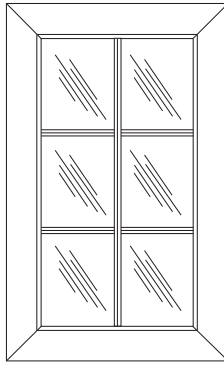

7250-6

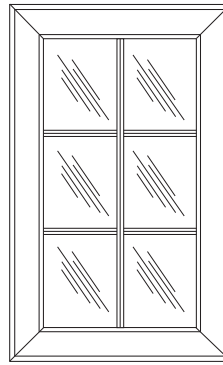

7260-6

## 3" Frame

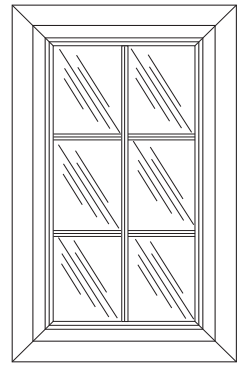

7220-6

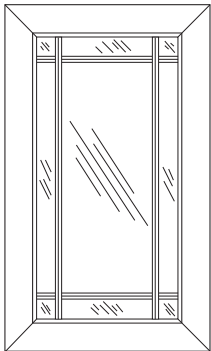

7200-9S

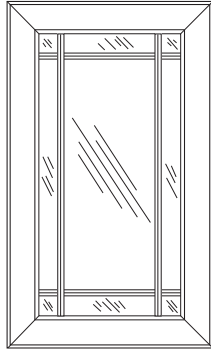

7210-9S

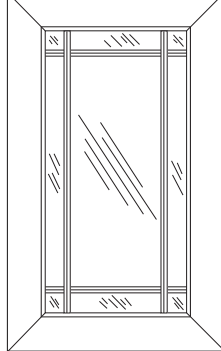

7250-9S

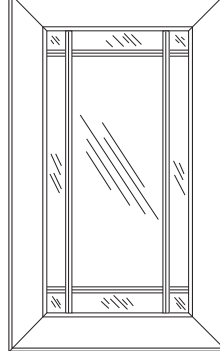

7260-9S

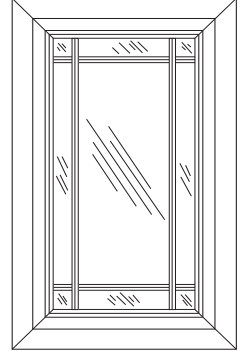

7220-9S

7200-6, 7200-9S Profiles: M1, M2, M3, M4, M5, M27, M28, & M29

7210-6, 7210-9S Profiles: M10, M11, M12, M13, M14

7250-6, 7250-9S Profiles: M1-2 1/2, M2-2 1/2, M3-2 1/2, M4-2 1/2, M5-2 1/2, M27-2 1/2, M28-2 1/2, M29-2 1/2

7260-6, 7260-9S Profiles: M10-2 1/2, M11-2 1/2, M12-2 1/2, M13-2 1/2, M14-2 1/2

7220-6, 7220-9S Profiles: M1-3, M2-3, M3-3, M4-3, M5-3, M10-3, M11-3, M12-3, M13-3, M14-3, M27-3, M28-3, M29-3

- Standard outside edges are available on 7200 series mitered doors with Profiles: M1 thru M7, M19, M25 thru M29, M31 & M32.

## Call for current pricing

# **MITTERED DRAWER FRONT PROFILES**

# Mitered Drawer Front Profiles

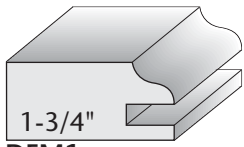

DFM1

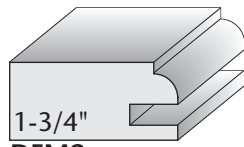

DFM2

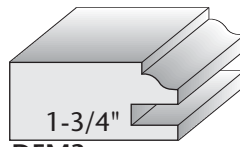

DFM3

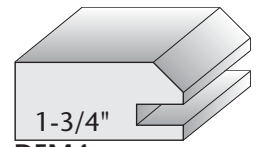

DFM4

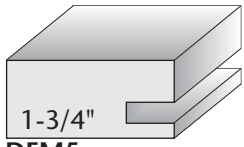

DFM5

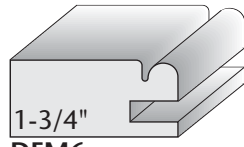

DFM6

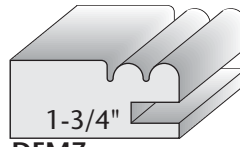

DFM7

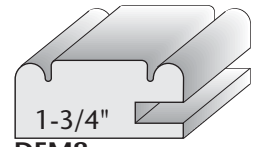

DFM8

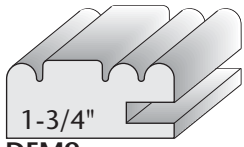

DFM9

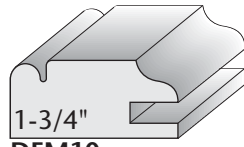

DFM10

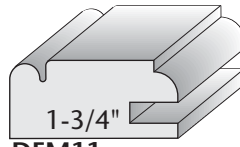

DFM11

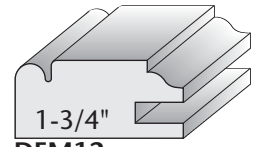

DFM12

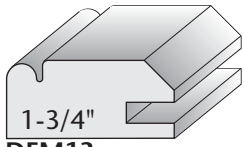

DFM13

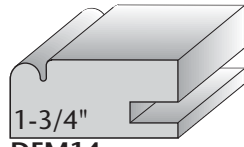

DFM14

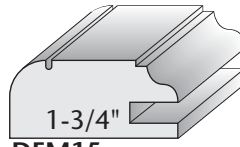

DFM15

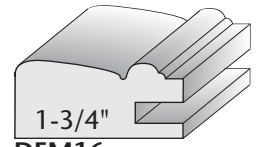

DFM16

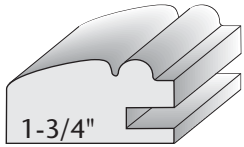

DFM17

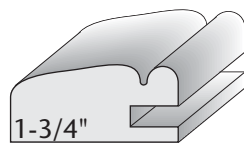

DFM18

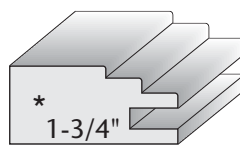

DFM19

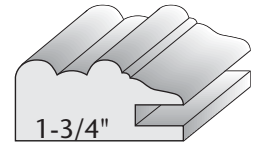

DFM20

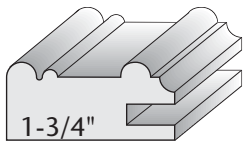

DFM21

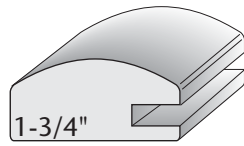

DFM22

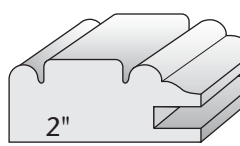

DFM23

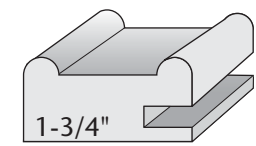

DFM24

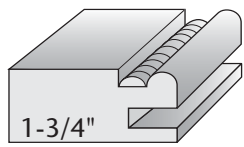

DFM25

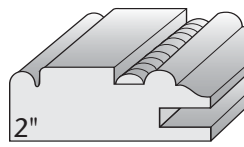

DFM26

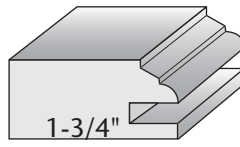

DFM27

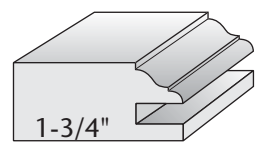

DFM28

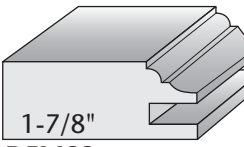

DFM29

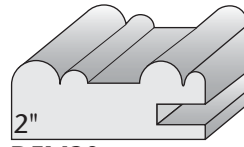

DFM30

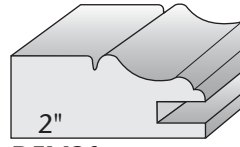

DFM31

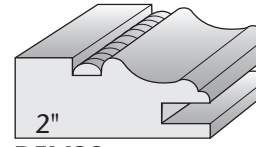

DFM32

\* Used with edge E-17

• Standard Outside Edges can be applied to Profiles: DFM1 thru DFM7, DFM19, DFM25 thru DFM29, DFM31 & DFM32

# **MITTERED RAISED DRAWER FRONTS**

# Mitered Drawer Fronts

## Raised Panel

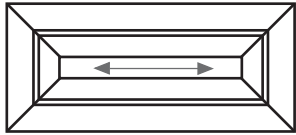

7005

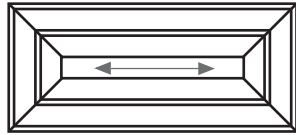

7015

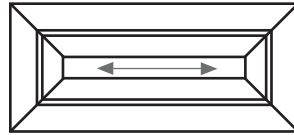

2"

7035

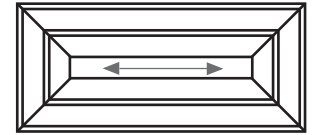

2"

7045

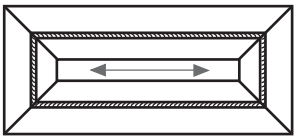

7005RM\*

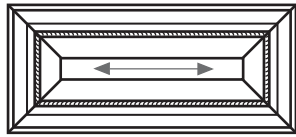

7015RM\*

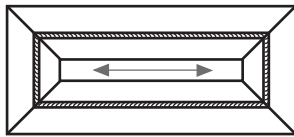

2"

7035RM\*

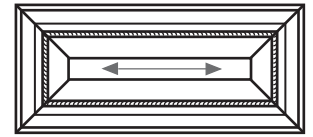

2"

7045RM\*

7005

Profiles: DFM1 thru DFM7, DFM19, DFM27, DFM28 & DFM29

7015

Profiles: DFM8 thru DFM18, DFM20, DFM21, DFM22, & DFM24

7035

Profiles: DFM31

7045

Profiles: DFM23, & DFM30

7005RM

Profiles: DFM25

7015RM

Profiles:

7035RM

Profiles: DFM32

7045RM

Profiles: DFM26

- Standard outside edges are available on 7005, 7005RM, 7035, 7035RM mitered drawer fronts.
- Raised Panel drawer front grain direction will be horizontal except for raised panel Profiles F & G.
- Mitered drawer front stiles and rails are 1-3/4" wide, unless otherwise noted.

## Call for current pricing

*\* Rope Molding Drawer Front*

*All Prices Per Square Foot – Outside Edging for 7005, 7005RM, 7035 & 7035RM Drawer Fronts Not Included*

# **MITTERED RECESSED DRAWER FRONTS**

# Mitered Drawer Fronts

## Recessed Panel

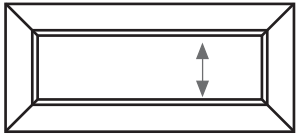

7105

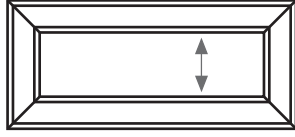

7115

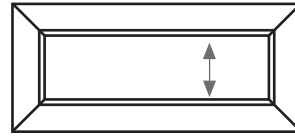

2"

7135

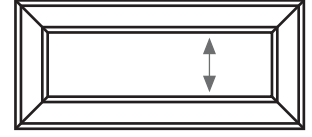

2"

7145

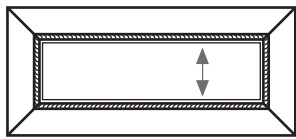

7105RM\*\*

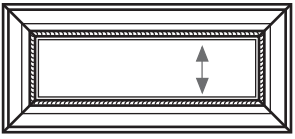

7115RM\*\*

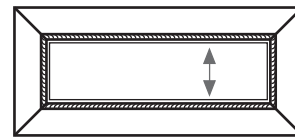

2"

7135RM\*\*

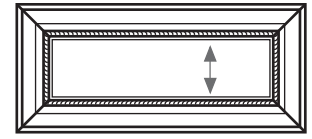

2"

7145RM\*\*

7105	Profiles: DFM1 thru DFM7, DFM19, DFM27, DFM28 & DFM29
7115	Profiles: DFM8 thru DFM18, DFM20, DFM21, DFM22, & DFM24
7135	Profiles: DFM31
7145	Profiles: DFM23, & DFM30
7105RM	Profiles: DFM25
7115RM	Profiles:
7135RM	Profiles: DFM32
7145RM	Profiles: DFM26

- Standard outside edges are available on 7105, 7105RM, 7135, 7135RM mitered drawer fronts.
- Mitered drawer front stiles and rails are 1-3/4" wide, unless otherwise noted.

Call for current pricing

\* Red Birch Plywood Panel used on Recessed Panel Drawer Fronts.

\*\* Rope Molding Drawer Front

All Prices Per Square Foot – Outside Edging for 7105, 7105RM, 7135 & 7135RM Drawer Fronts Not Included



# APPLIED MOLDING PROFILES

# Applied Molding Profiles

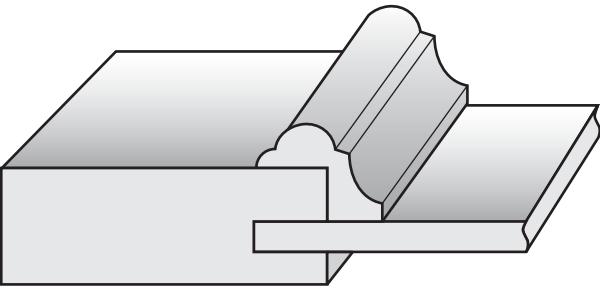

AP-1

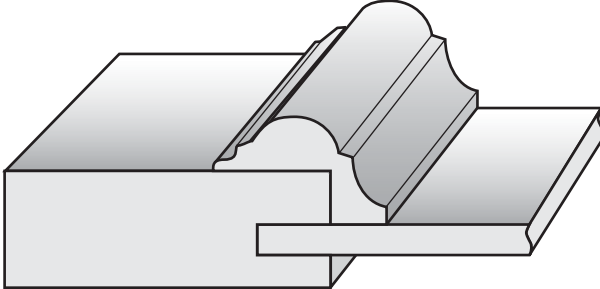

AP-2

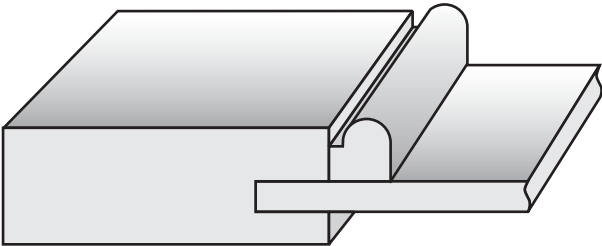

AP-3

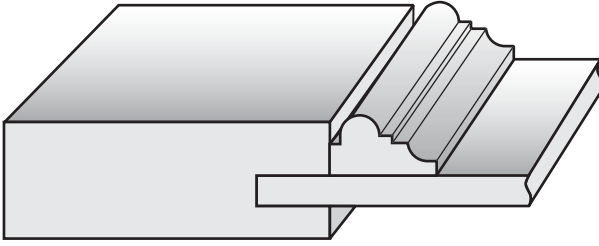

AP-4

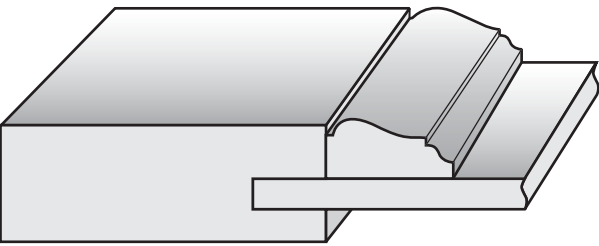

AP-5

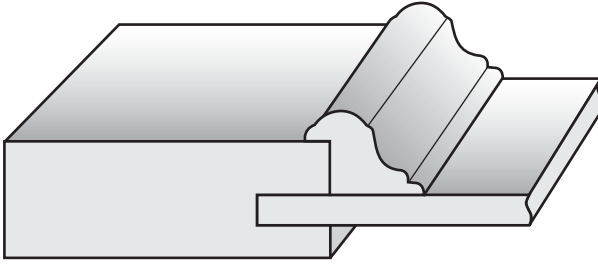

AP-6

*AP-4, AP-5 & AP-6 can be used only on recessed and reverse raised panel doors.*

# **APPLIED MOLDING RAISED PANEL PROFILES**

# Applied Molding Door Raised Panel Profiles

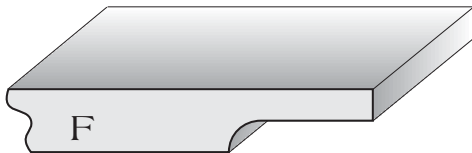
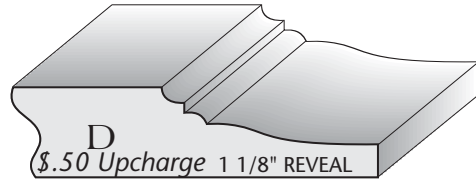
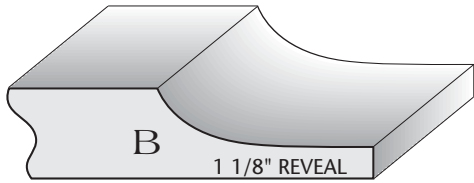

"F" Series Panels

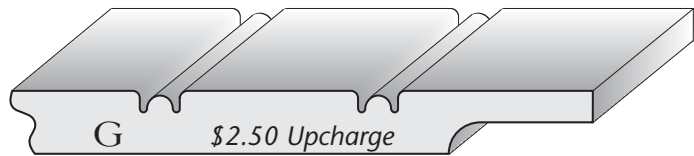

"G" Series Panels

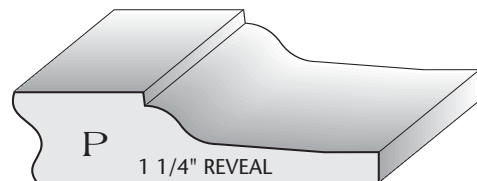
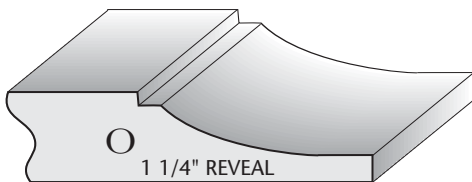

# **APPLIED MOLDING RAISED PANEL DOORS**

# Applied Molding

## Raised Panel Doors

**2 1/4" Frame**

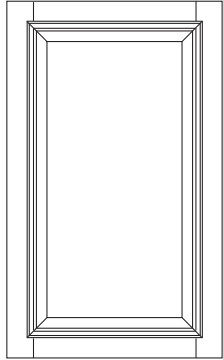

8000

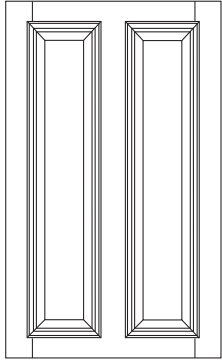

8020

**2 1/2" Frame**

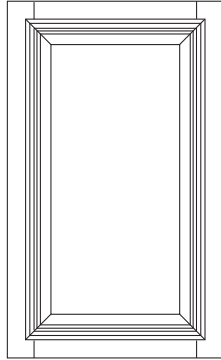

8010

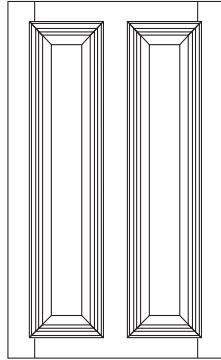

8030

**3" Frame**

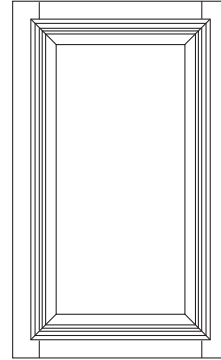

8040

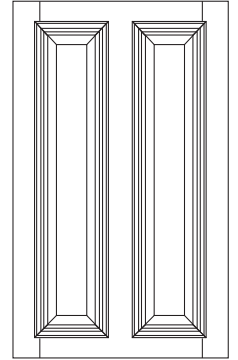

8050

## Raised Panel Drawer Fronts

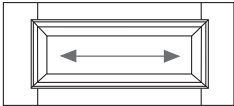

2 1/4" Frame 8005



2 1/2" Frame 8015

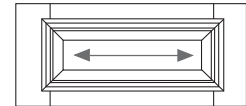

3" Frame 8045

- Raised Panel drawer front grain direction will be horizontal except for raised panel Profiles F & G.
- Drawer Front Rails are 1-3/4".

Call for current pricing

# **APPLIED MOLDING RECESSED PANEL DOORS**

# Applied Molding

## Recessed Panel Doors

**2 1/4" Frame**

**2 1/2" Frame**

**3" Frame**

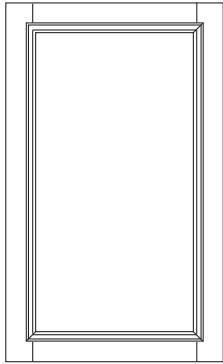

8100

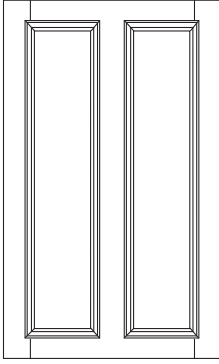

8120

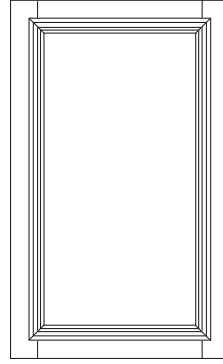

8110

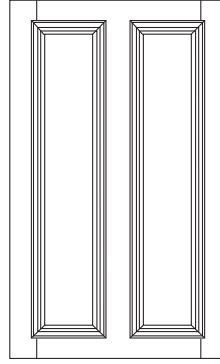

8130

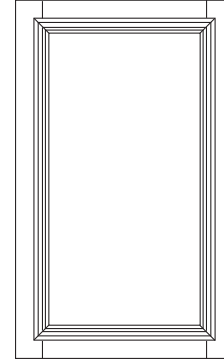

8140

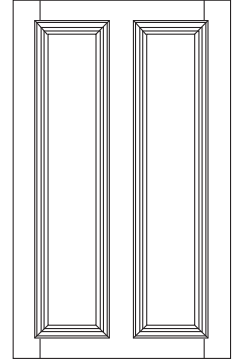

8150

## Recessed Panel Drawer Fronts

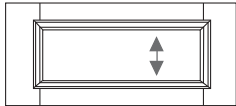

2 1/4" Frame 8105



2 1/2" Frame 8115



3" Frame 8145

- Drawer Front Rails are 1-3/4".

Call for current pricing



# **APPLIED MOLDING GLASS & MULLION DOORS**

# Applied Molding

## Glass & Mullion Doors

2 1/4" Frame

2 1/2" Frame

3" Frame

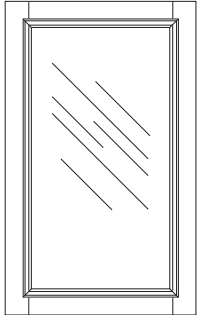

8200

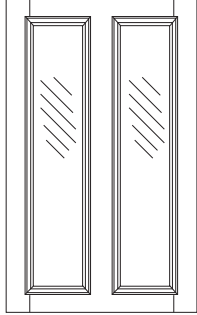

8220

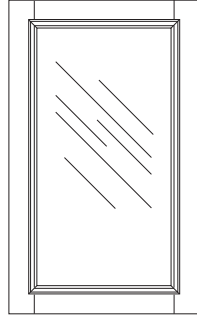

8210

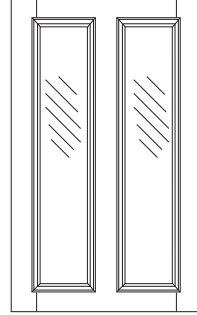

8230

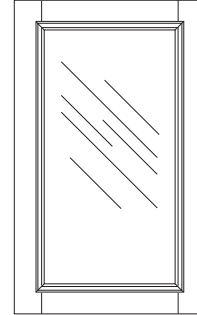

8240

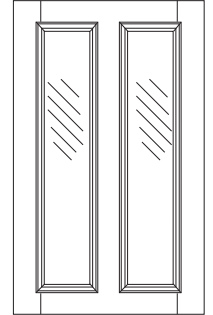

8250

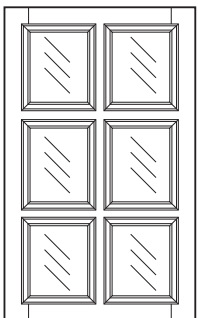

8200-6

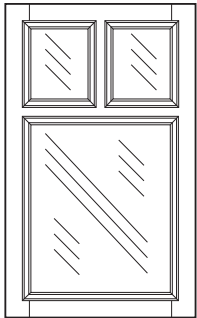

8200-3S

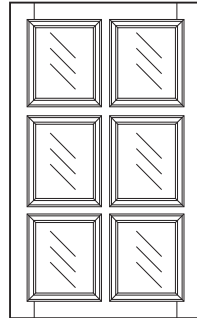

8210-6

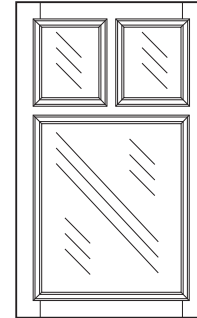

8210-3S

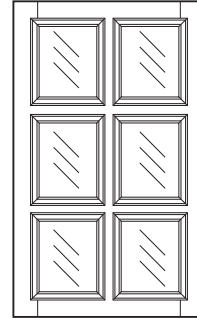

8240-6

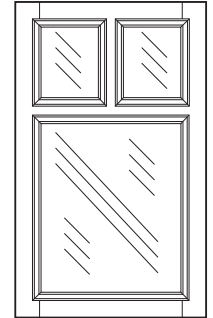

8240-3S

## Call for current pricing

*Specify number of lites by adding a dash-number to door style number (8200-6 has 6 lites)  
All Prices Per Square Foot - Outside Edging Not Included - Glass and Stops Not Included*

# SLAB DOORS

# Slab Doors

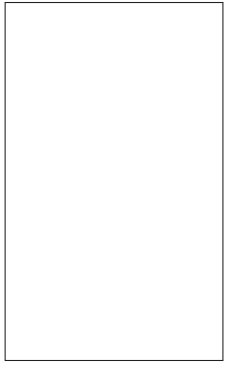

1000

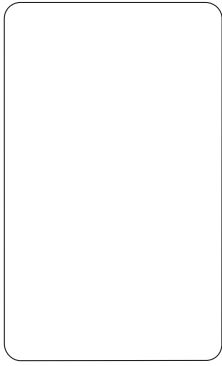

Radius Corners 1010

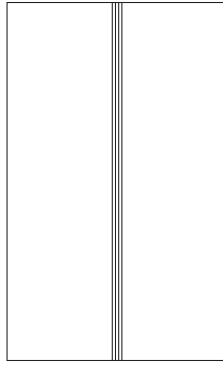

Centered Flute 1020

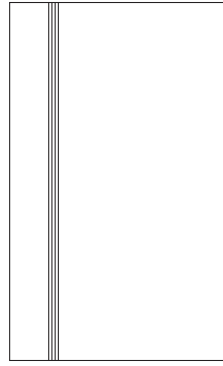

Offset Flute 1030

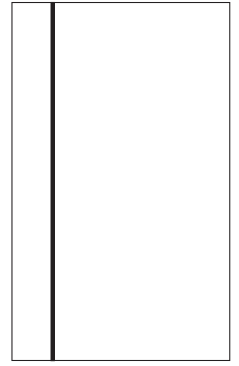

Single Inlay 1040

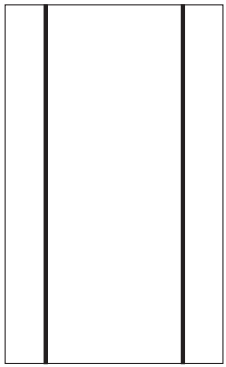

Double Inlay 1050

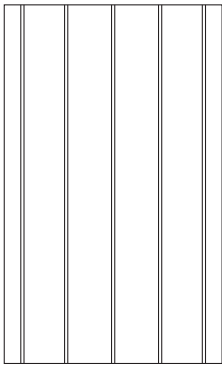

Beaded 1060

Detail — on 3" Centers 1060

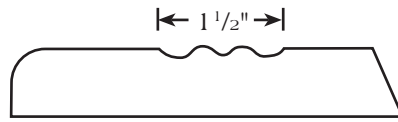

Flute Detail 1020/1030



Inlay Detail\* 1040/1050



Radius Bead 1060RB



"V" Bead 1060VB

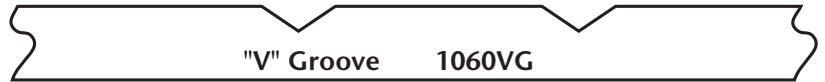

"V" Groove 1060VG

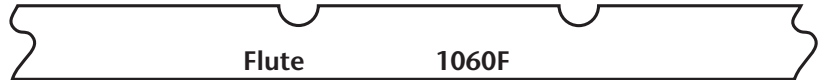

Flute 1060F

Call for current pricing

\*Inlay is 1/4" Wide Black Walnut or White Maple  
 \*\*Radius corners on 1010 are 3/4" unless otherwise specified

All Prices Per Square Foot - Outside Edging Not Included

# **SLAB DRAWER FRONTS**

# Slab Drawer Fronts

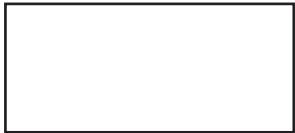

1005



2-1/4" Stiles

1006



2-1/2" Stiles

1007



3" Stiles

1008



Radius Corners 1015



Centered Flute 1025



Offset Flute 1035

- Radius corners on 1015 are 3/4" unless otherwise specified
- Grain direction on slab drawer fronts is horizontal
- Drawer fronts 1006, 1007, 1008 are available with either inside profiles 5 or 6



## Call for current pricing

# DOVETAIL BOXES

# Dovetail Drawer Boxes

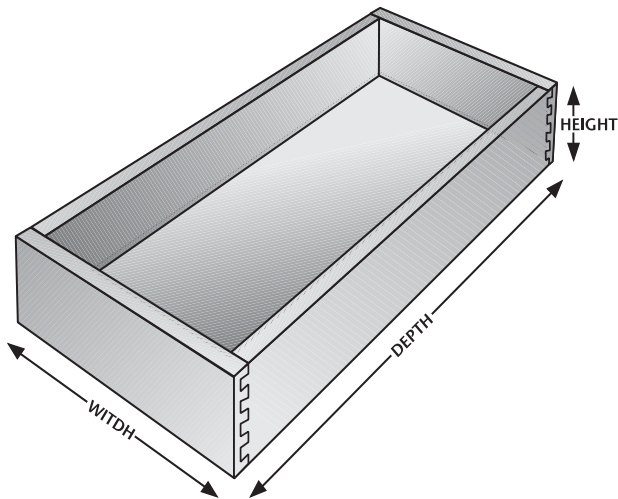

SIZE LIMITATIONS	
Maximum Width	49"
Maximum Depth	34"
Maximum Height	23"
Minimum Width	4"
Minimum Depth	4"
Minimum Height	2"

- *Drawer boxes are assembled, sanded and ready for finish.*
- *Top edges have 1/8" C.R. on sides and inside of front and back on drawer boxes, and on all sides and ends of pullouts.*
- *Drawer box height should be in 1" or 1/2" increments, if at all possible.*
- *Scoop handle fronts are available on pullouts with a \$2.00 upcharge.*
- *1-1/4" Undermount Notches are available with a \$1.00 per notch upcharge.*
- *3-3/4" Undermount Notches are available with a \$2.00 per notch upcharge.*
- *Bottom Mount and Flush Mount Bottoms are available with a \$1.00 per box upcharge.*

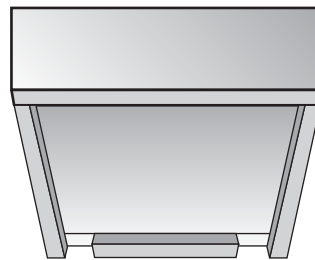

Undermount Notches

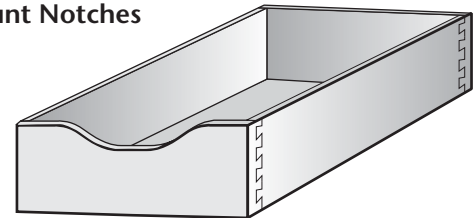

Pullout Scoop

## Bottom Panel Options

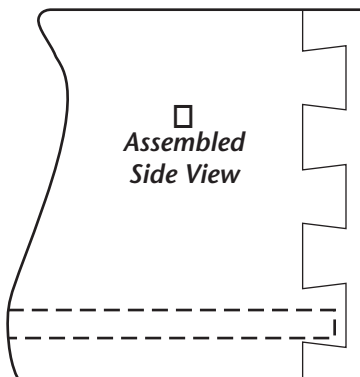

Recessed Bottom

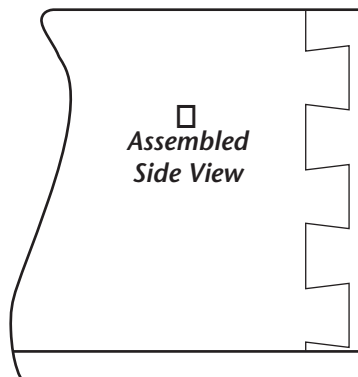

Bottom Mount

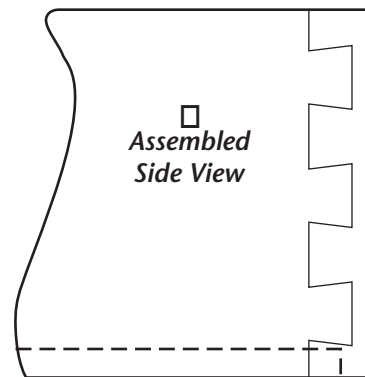

Flush Mount Bottom

*Drawer box pricing on next page*



# Dovetail Drawer Boxes

STYLE	DRAWER BOX DESIGN
100	Drawer Box - 1/2" Sidewall
110	Drawer Box - 5/8" Sidewall
105	Pullout - 1/2" Sidewall
115	Pullout - 5/8" Sidewall

## ***DRAWER BOX PRICING IS MADE UP OF TWO PARTS:***

***1.) Sidewall Price***

***2.) Bottom Price***

***Step 1: Calculate the square footage of the sidewall material***       $(W + D) \times 2 \times H \div 144 = \text{Square Footage}$

***Then multiply by the sidewall square footage price***

***Step 2: Calculate the square footage of the bottom material***       $(W \times D) \div 144 = \text{Square Footage}$

***Then multiply by the bottom square footage price***

***Add the prices from Steps 1 and 2 to determine the price of an assembled drawer. There is 2 square foot minimum for sidewall pricing and a 1 square foot minimum for bottom pricing.***

## Call for current pricing

***\*\* 11 Ply Birch***

***All Prices Per Square Foot***





# DOVETAIL DRAWER BOX ORDER FORM

CUSTOMER _____	JOB NO./NAME _____
ADDRESS _____	P.O. # _____
PHONE _____	FAX _____ EMAIL _____

MATERIAL _____	<input type="radio"/> 1/2" <input type="radio"/> 5/8" SIDEWALL THICKNESS
<input type="radio"/> 1/4" <input type="radio"/> 3/8" MATCHING PLYWOOD BTM	<input type="radio"/> 1/4" AROMATIC CEDAR BTM <input type="radio"/> 1/4" MELAMINE BTM
<input type="radio"/> 5/16" <input type="radio"/> 1/2" DRAWER BTM RECESS	<input type="radio"/> BOTTOM MOUNT BTM <input type="radio"/> FLUSH MOUNT BTM
<input type="radio"/> PULLOUT SCOOPS <input type="radio"/> 2" UNDERMOUNT NOTCHES	<input type="radio"/> BLUM LOCKING DEVICE HOLES

#	QTY	WIDTH	DEPTH	HEIGHT	STYLE	COMMENTS
1						
2						
3						
4						
5						
6						
7						
8						
9						
10						
11						
12						
13						
14						
15						
16						
17						
18						
19						
20						
21						
22						
23						
24						
25						
26						
27						
28						
29						
30						

SHIPPING INSTRUCTIONS \_\_\_\_\_



14002 CANYON ROAD E. • PUYALLUP, WASHINGTON 98373  
(253) 531-9132 • FAX (253) 531-8271 • 1-888-531-9132  
email: [sales@ruckmanscabdoor.com](mailto:sales@ruckmanscabdoor.com)